



DECAL PLACEMENT MANUAL FOR THE

Lightning

P-38



Detail Note

This aircraft had the side hinged upper canopy section. Use Tamiya parts H7 & H13.

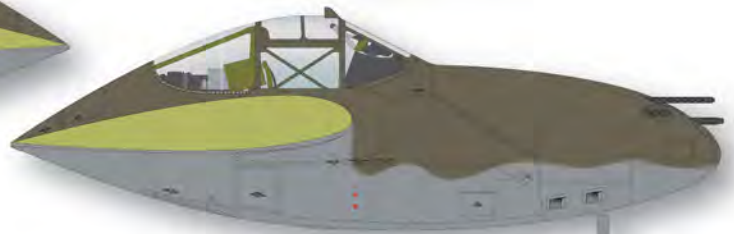
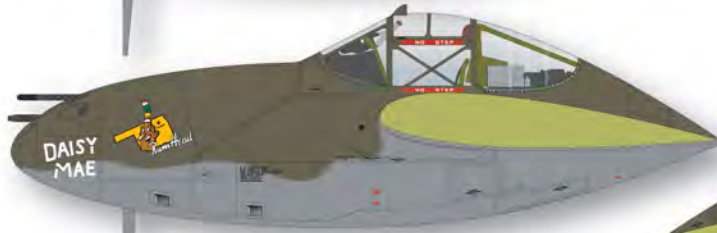

Detail Note

The original blue disk insignia had the yellow border added, and it is likely the original position remained the same, with the yellow border interrupted by the aileron leading edge.

Detail Note

This aircraft had the SCR-522 radio set installed. See detail page.

Detail Note

This aircraft had the side hinged upper canopy section. Use Tamiya parts H7 & H13.

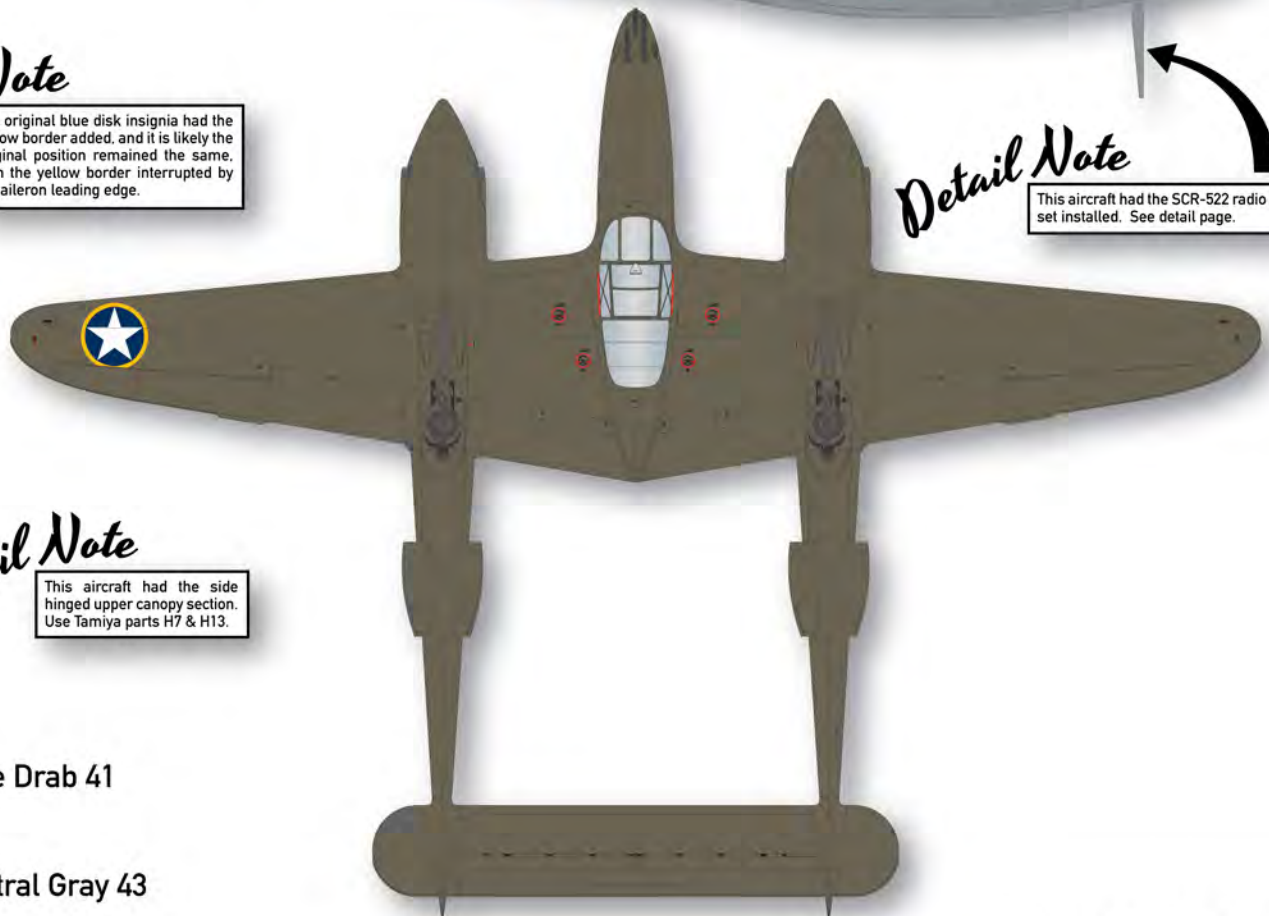

1st Lt. Joel A. "Rum" Owens joined the Army before the war as an aviation cadet. After completing pilot training, he was assigned to 27th Pursuit Squadron, 1st Pursuit Group on 2 June 1941. The 27th arrived in England in August 1942 and flew to North Africa in November. On 30 November now Captain Owens claimed a Bf 109F destroyed and one damaged. On 4 December Owens claimed another Bf 109 destroyed. A month later Owens was given command of the 27th FS. On 12 January 1943 Owens claimed an Italian Reggiane as probably destroyed and on 31 January he destroyed another Bf 109. In March Owens was promoted to Major and transferred to the 14th Fighter Group as Deputy CO. On 10 May he made his final two claims, 2 Bf 109s destroyed, making him an ace. Owens retired from the Air Force in 1972 and graduated from the University of Colorado 2 years later.



Detail Note

Photos are inconclusive on the colors of the swastika kill markings. We believe the red/yellow ones are correct, but we'll leave the decision to you.

Detail Note

The upper canopy section opened upward on this aircraft.

32308



Detail Note

She carried the iron sight post forward of the windscreen.

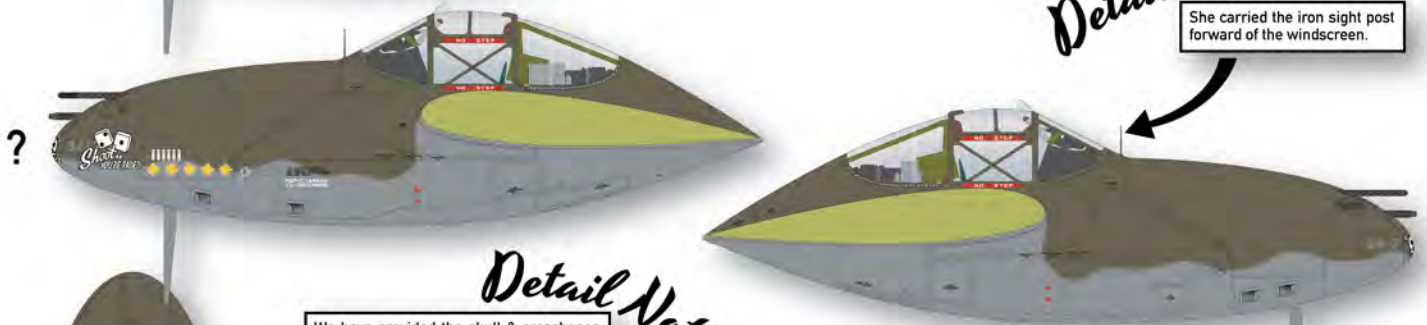

Detail Note

We have provided the skull & crossbones on the nose in halves or as a single decal. Use whichever you find works best for you.

32308



Detail Note

In many cases, the yellow (and later red and even later blue) outline on the insignias was not carried across the main gear door.

Detail Note

This aircraft had the SCR-522 radio set installed. See detail page.

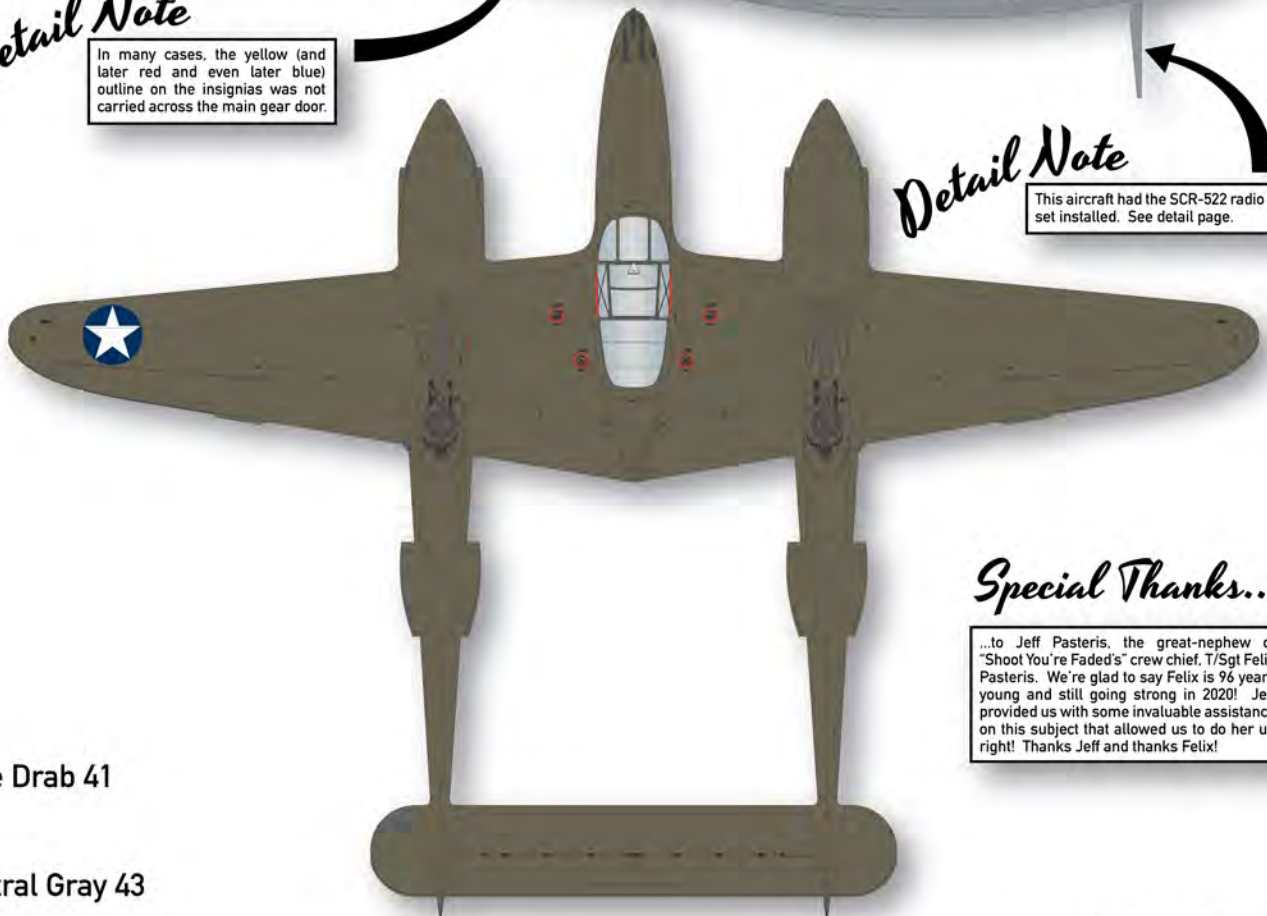

Special Thanks...

...to Jeff Pasteris, the great-nephew of "Shoot You're Faded's" crew chief, T/Sgt Felix Pasteris. We're glad to say Felix is 96 years young and still going strong in 2020! Jeff provided us with some invaluable assistance on this subject that allowed us to do her up right! Thanks Jeff and thanks Felix!





John MacKay joined the 1st Fighter Group as a 2 Lt on 9 January 1943. Assigned to the 27th Fighter Squadron, MacKay claimed a Bf 109 destroyed on 23 March. On 5 April he claimed two Ju 52s and a single Fw 187 destroyed. MacKay did not score again until 25 May when he claimed two more Bf 109s. MacKay also claimed a Bf109 probable on the last day of May before being transferred from the group in June. MacKay later served in Korea, retiring from the U.S. Air Force a major in 1962.



Three atmospheric shots of "Shoot You're Faded" in action in North Africa in 1943. Note in the lower right shot that the yellow ring has not yet been applied to the boom insignia. Also note the single-color Mk.6 drop tanks - they may have been Neutral Gray or possibly a generic light/medium grey color as seen elsewhere. All three of her wheel hubs still carry the factory supplied hub caps.





Detail Note

The upper canopy section opened upward on this aircraft.

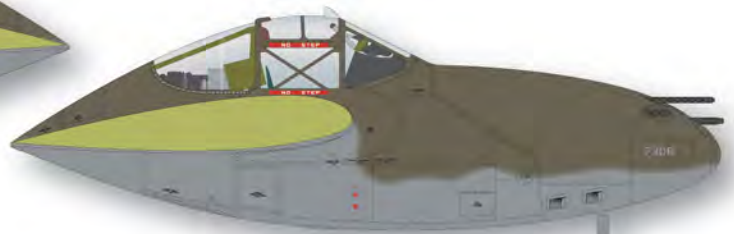
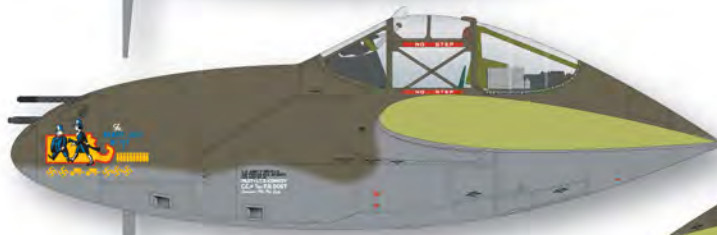

Detail Note

This aircraft had the SCR-522 radio set installed. See detail page.

-  Olive Drab 41
-  Neutral Gray 43
-  Dark Blue

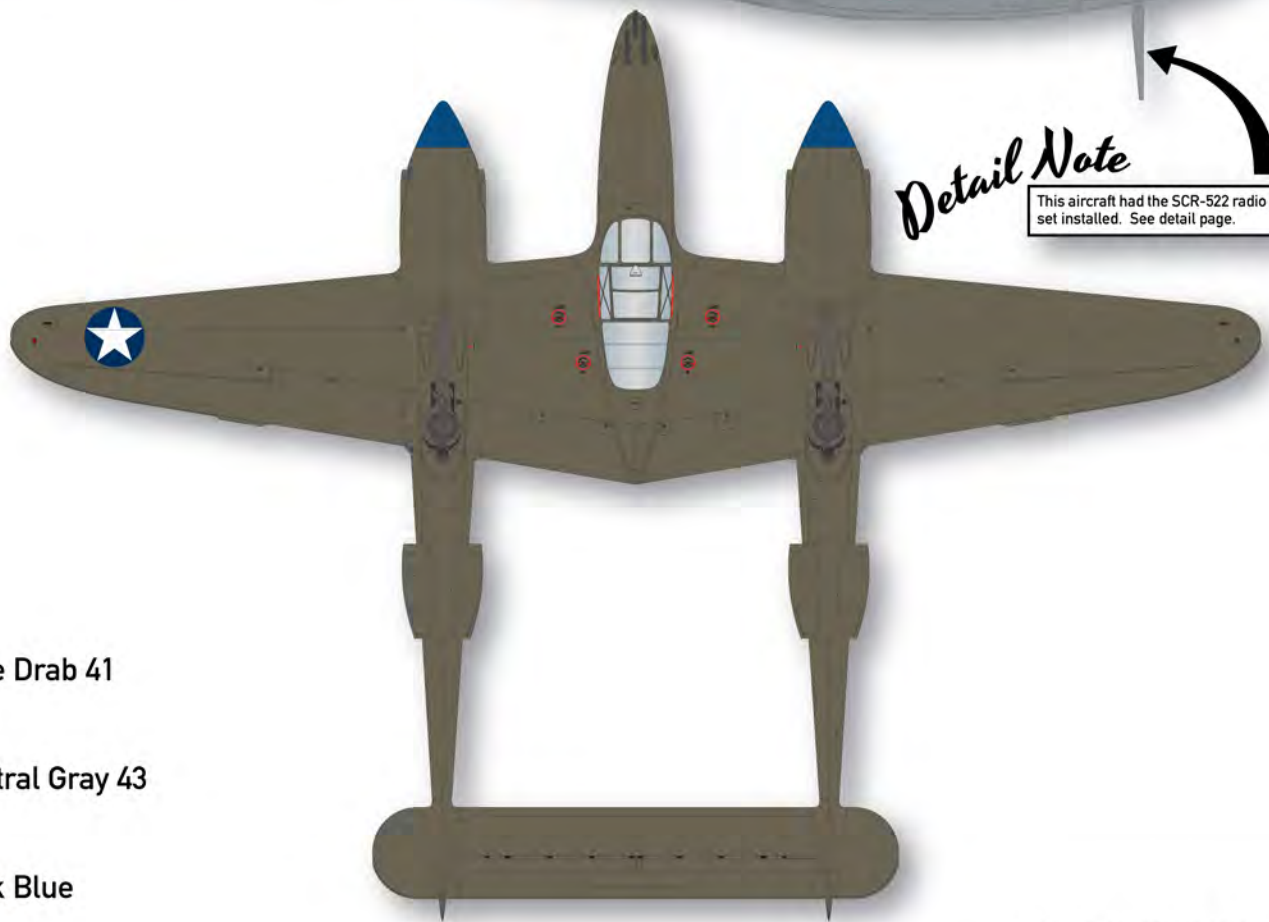



1 Lt. Daniel Kennedy joined the 27th Fighter Squadron in January 1943. He made his first claim, a Macchi C.202 damaged, while flying a P-38F on 28 February. After switching to the P-38G he claimed an Fw 190 destroyed on 8 March and a Bf 109 on 31 May. His best day as a fighter pilot was 9 June when he shot down three Bf 109s and damaged a fourth, most likely flying his regular mount "Beantown Boys" pictured here with his full score.

Kennedy transferred from the 1st Fighter Group on 27 June 1943 and returned to the United States an ace. Exactly one month later 2 Lt. John R. Witley bellied into the camp area after losing an engine on take-off and "Beantown Boys"

Above, a rare color shot of Beantown Boys. There does not seem to have been much standardization in the use (or lack of use) of the yellow surround on the US insignia at this period in North Africa. We have depicted Beantown Boys with plain blue disks, which it clearly had on the wing (at least). Her fuselage insignias may have had the yellow ring, in which case you can borrow them from another aircraft on the sheet.

At right, Kennedy is seen adding another kill mark to his ship, or at least pretending to for the camera...



Detail Note

This aircraft had the side hinged upper canopy section. Use Tamiya parts H7 & H13.



Detail Note

Many P-38s exhibited dark staining along all skin joints from the sealing tape used when they were shipped overseas. But that usually shows as an unaltered OD or NG strip along the panel, with darker areas on either side from the varnish used to seal the tape. In the case of "Dear John" we're not sure what the darker areas on the nose are. They could be OD touch ups, or something else entirely.

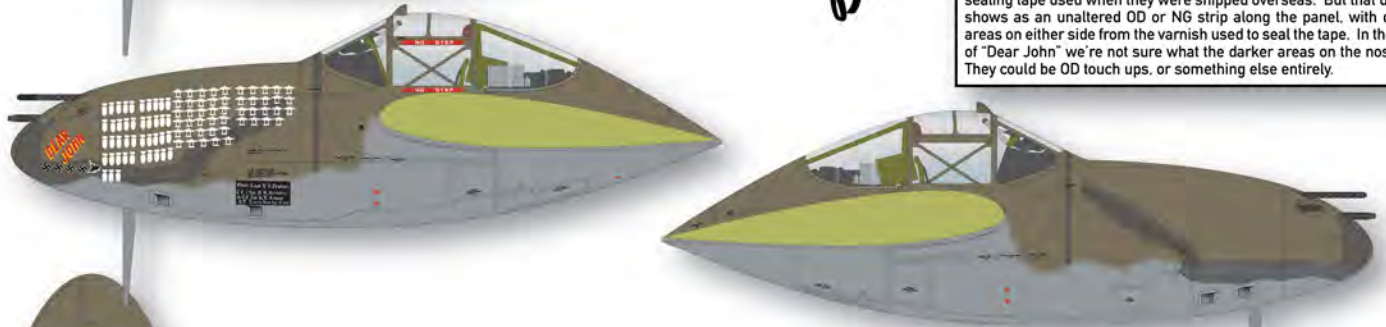

Detail Note

The original blue disk insignia had the red border and white bars added during 1943, and it is likely the original position remained the same, with the red border thus slightly overlapping the leading edge of the aileron.

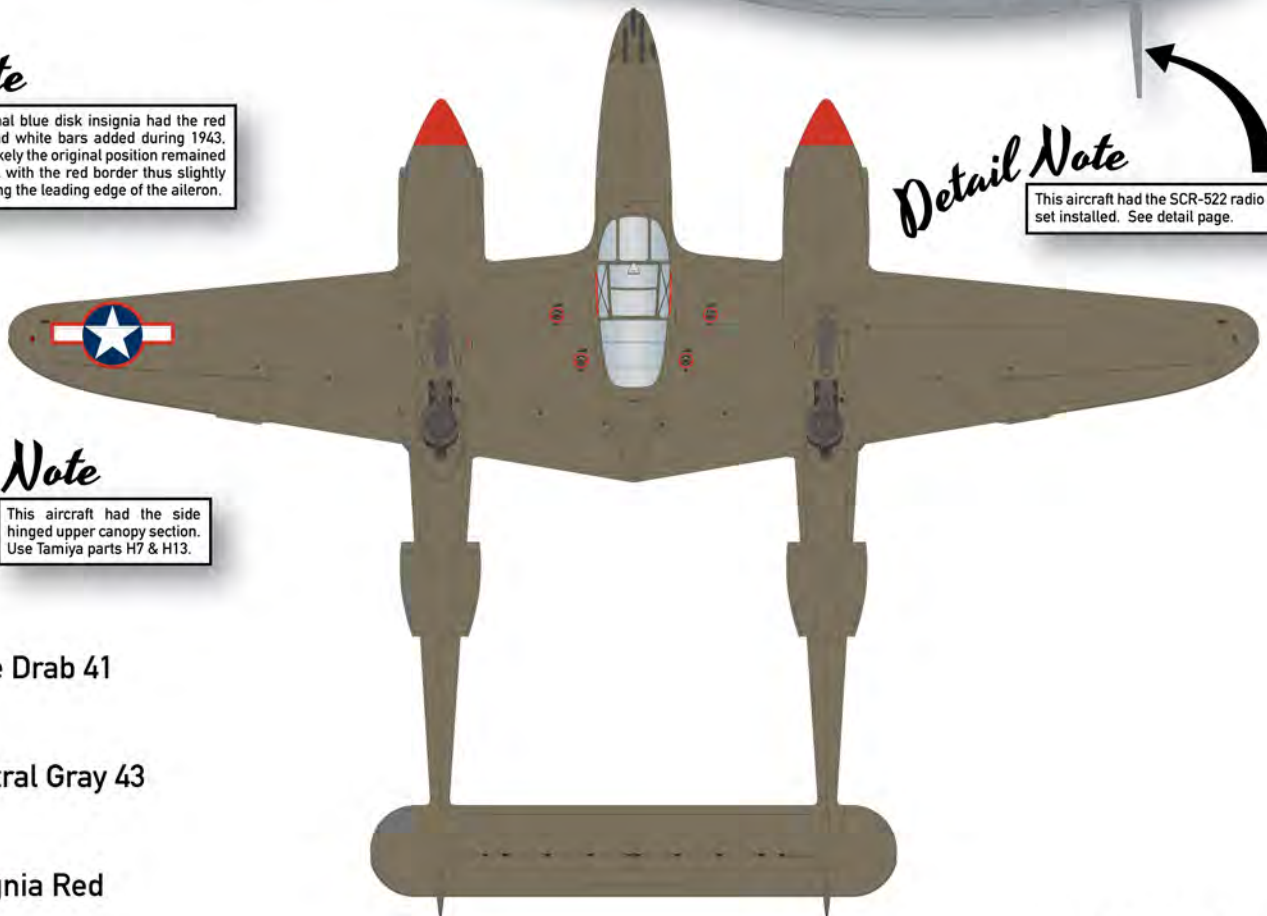

Detail Note

This aircraft had the SCR-522 radio set installed. See detail page.

Detail Note

This aircraft had the side hinged upper canopy section. Use Tamiya parts H7 & H13.



Captain Edward S. Newbury was credited with four confirmed aerial victories including two Ju 87 Stukas and a single Ju 52/3m on 5 April 1943. The only other claim we could find for him is a Bf 109 damaged on 29 April. Newbury and "Dear John" flew over 300 hours in combat together as documented by the extensive score board on the nose at the time this photo was taken. "Dear John" was lost 10 February 1944 on a dive bombing & strafing mission near Monteratondo, Italy. Her pilot that day, 2 Lt. Thomas I. Collier of the 71st FS was too low, and the explosion of his own bomb sheered off the tail of the aircraft. He was KIA.



"Dear John" had a very catchy looking scoreboard. Some very creative ground crewman made a P-38 silhouette stencil, but we're not sure what those signify separate from the bomb markings. Note the carefully applied Old English style crew names. Again, we're not sure what we're seeing in the dark staining along the edges of the gun access panel, but it certainly gives her some character.



May 43

Detail Note

The upper canopy section opened upward on this aircraft.



Detail Note

"The Sad Sack" carried the iron sight post forward of the windscreen.

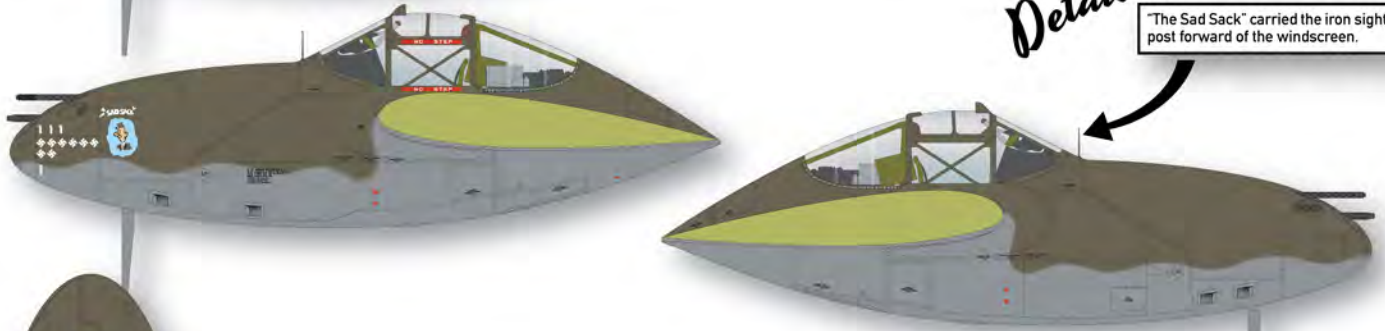

Note

We did not include the national insignias for this version of "The Sad Sack". They can be borrowed from other aircraft on the decal. We believe the wing insignias lacked the yellow outlines.

Detail Note

This aircraft had the SCR-522 radio set installed. See detail page.

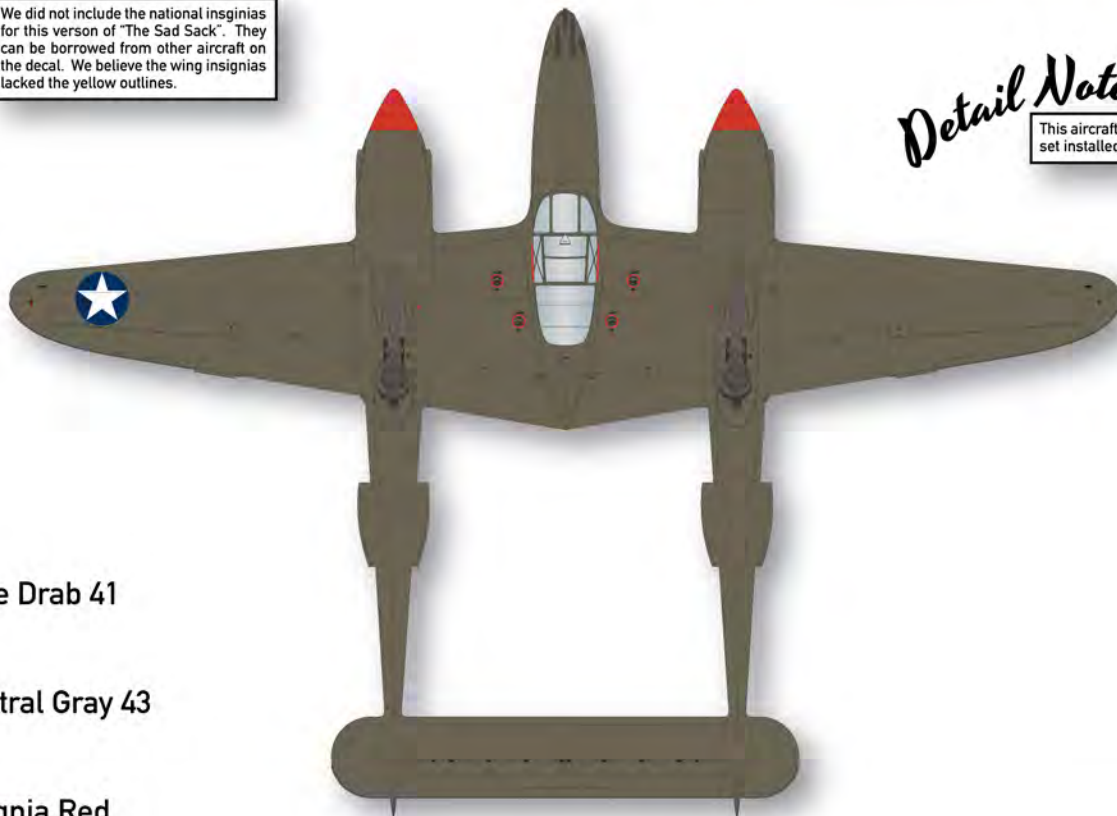

-  Olive Drab 41
-  Neutral Gray 43
-  Insignia Red



Capt. Osher and his ground crew posing with "The Sad Sack." By this time she had already robbed the Axis of 11 of their aircraft in 86 missions, and had seen 280 hours of combat. Note the hub caps on the mains as well as the nose wheel.

Lockheed P-38F-15-LO, 43-2112, "The Sad Sack" was the highest scoring P-38 outside of the PTO, and may have scored as many as 16 aerial victories. Leading 82 FG ace "Dixie" Sloan made his first claim, and the first claim for the group, when he destroyed a Bf 109 while flying "The Sad Sack" on 7 January 1943. The 27th Fighter Group's CO, Major Robert E. Kirtley, was at the controls of 43-2112 on 21 February when he shot down a Ju 88 and an Ar 196, and claimed a second Ju 88 as probable.

Captain Ernest K. Osher, the CO of the 96th Fighter Squadron, scored four of his eventual five aerial victories in "The Sad Sack," the first of which was a Bf 109 destroyed, and another damaged on 22 March. On 5 May Capt. Osher shot down a Macchi C.200 and an SM.82. The following day Osher damaged a Bf 109. He closed out his scoring on 11 May when he shot down a Bf 109 over Sicily.

The remaining three victories on her scoreboard belong to 2 Lt John B. Cappel. Cappel was flying "The Sad Sack" on 11 April 1943 when he downed 2 Ju 52s and again on 29 April when he destroyed a Bf 109 and damaged another.

Jul - Sep 43



Detail Note

The original blue disk insignia had the red border and white bars added during 1943, and it is likely the original position remained the same, with the red border thus slightly overlapping the leading edge of the aileron.

Note

Your guess is as good as ours what the "L R P" below the nose art on this later version of "Sad Sack" means!

May 44



Note

By May of 1944, Sad Sack's Olive Drab camouflage was noticeably faded. Feel free to weather her up!





Three 95th FS pilots with "The Sad Sack." This ship may hold the record for longevity in combat of any P-38.

Lockheed P-38F-15-LO, 43-2112 "The Sad Sack" was flown by as many as 30 pilots, surviving in almost daily combat operations for an incredible 18 months.

In 1944 she was assigned to 2 Lt Roland Leeman, who added to her already impressive score. On 24 February 1944 "Tuffy" Leeman flying "The Sad Sack" destroyed an Me 210. On 30 March he claimed a Bf 109 damaged, and on 3 April he destroyed another Bf 109. On 13 April he shot down a Ju 88, and damaged another Bf 109 on 5 May. At the end of the month "The Sad Sack," with Leeman at the controls, destroyed three enemy aircraft on the ground.

On 29 May 1944 "The Sad Sack" was shot up during a low level strafing mission over Yugoslavia. Leeman was able nurse the aircraft back to Foggia, Italy where he belly-landed the veteran ship, although she was so damaged she had to be scrapped. Her illustrious combat career had resulted in 16 aerial victories, plus several more aircraft damaged and/or destroyed on the ground in an amazing total of 183 missions.

"The Sad Sack's" home base in 1944 was Vincenzo, one of the many outlying fields of the massive Foggia airfield complex in southern Italy.

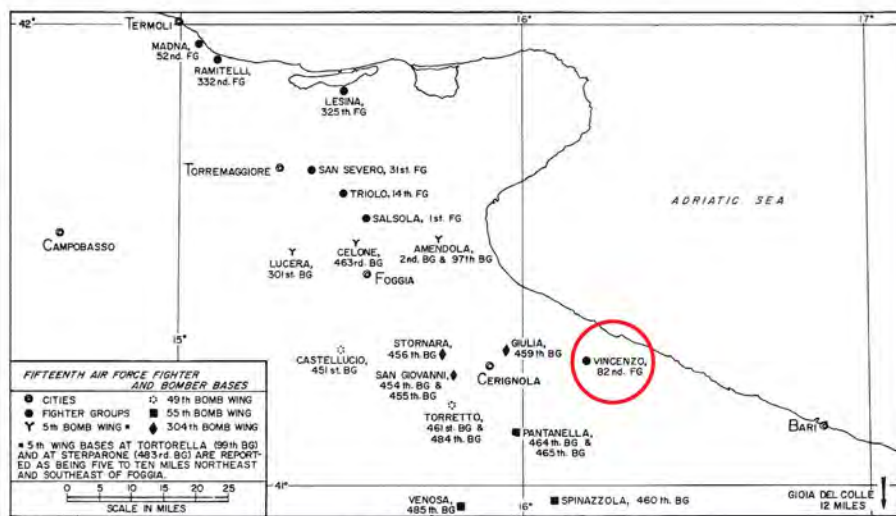

June 43



Detail Note

The upper canopy section opened upward on this aircraft.

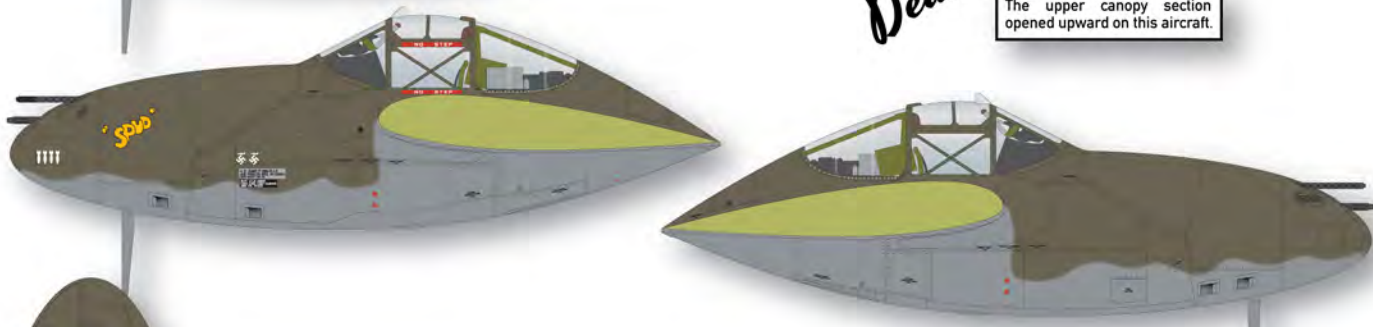

July 43

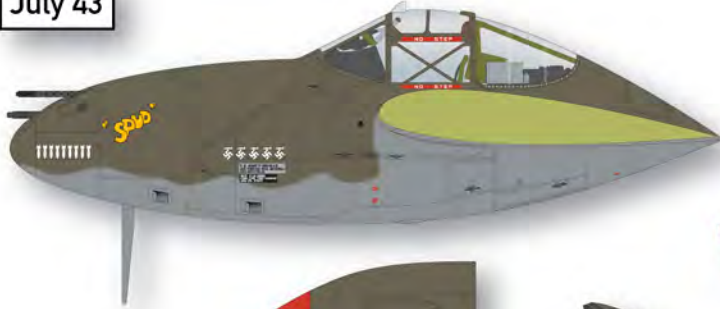

Detail Note

This aircraft had the SCR-522 radio set installed. See detail page.

For reasons unknown, only the front segment of the spinners were painted red at this time.



-  Olive Drab 41
-  Neutral Gray 43
-  Insignia Red



Liebers with his dapper moustache poses with his ship after the 5th kill marking was applied.

Larry Liebers destroyed a Macchi C.202 on 14 May 1943. He repeated that feat seven days later. On 18 June Liebers claimed two C.202s and one C.205 destroyed plus a C.202s damaged. On 10 July Liebers destroyed an Fw 190 over Sicily and damaged two more. He finished out his score when he shot down an Fw 190 on 20 August. It is likely that all of Liebers's claims were made in his personal P-38G "Spud". Liebers was killed in a flying accident in 1946 in Victorville, California.

Items to note are the hub caps, and the change to coloring of the spinners. For reasons unknown, they were completely red early on, and later only the forward segment was red, with the aft portion in OD. The Mk.6 tank appears to be some dark color overall. We have seen color photos of these tanks painted various colors, from OD/NG camouflage, to light grey, to a very dark green color.



Above, "Spud" is seen in June 1943 sporting four bomb marks and two kills.

Right, "Spud" now carries nine bomb marks and four kills.





Detail Note

The upper canopy section opened upward on this aircraft.

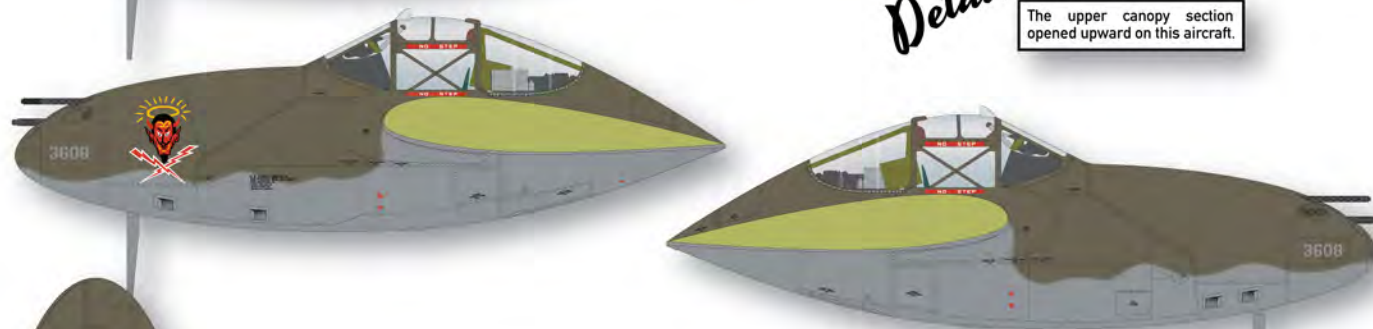

Detail Note

This aircraft had the SCR-522 radio set installed. See detail page.

-  Olive Drab 41
-  Neutral Gray 43
-  Insignia Red

2 Lt. Louis Curdes was flying this P-38G-15-LO when he destroyed a Macchi C.202 over Sardinia on 24 June 1943. By this time Curdes was already an ace, having claimed three Bf 109s on 29 April 1943, and two more 109s on 19 May. He added another pair of 109s to his total on 27 August, but was himself shot down and taken prisoner in the process. He escaped a few weeks later and survived behind enemy lines until 27 May 1944.

He requested combat duty in the Pacific, where he flew Mustangs. Curdes shot down a Ki-46 Dinah on 7 February 1945 giving him scores against all three major Axis air forces. Three days later he shot down an American C-47 that was attempting to land on an enemy held island. Curdes shot out each engine and forced the transport plane to ditch in the ocean. All 13 members aboard the C-47 were later rescued. Among those picked up was nurse Svetlana Valeria Shostakovich, niece of the famous composer Dmitri Shostakovich. Curdes had had a date with her the next night... and they were married in 1946!



At left, Curdes's ship featured nose art of a rather mean looking Satan. We did not have a photo of the whole ship that was of sufficient quality to include here.

Below, Curdes (far right) poses with squadron mates at their Tunisian base in 1943.





Detail Note

The upper canopy section opened upward on this aircraft.

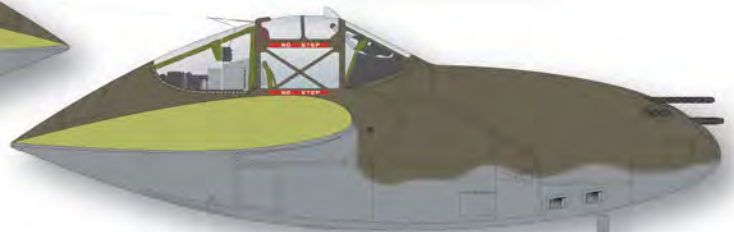
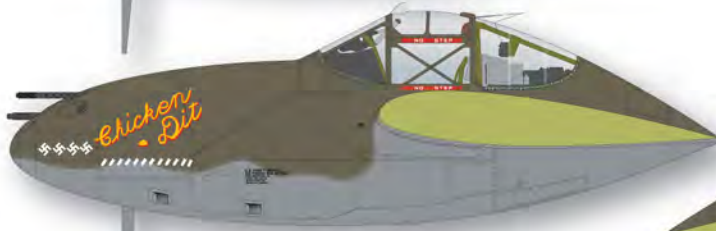

Detail Note

Some P-38s appear to have had their tail numbers painted over (possibly at the theater depot or before being shipped overseas), and some probably had it, but it was covered in the heavy exhaust and light brownish-grey tetraethyl lead deposits so common on the P-38.

Detail Note

This aircraft had the SCR-522 radio set installed. See detail page.

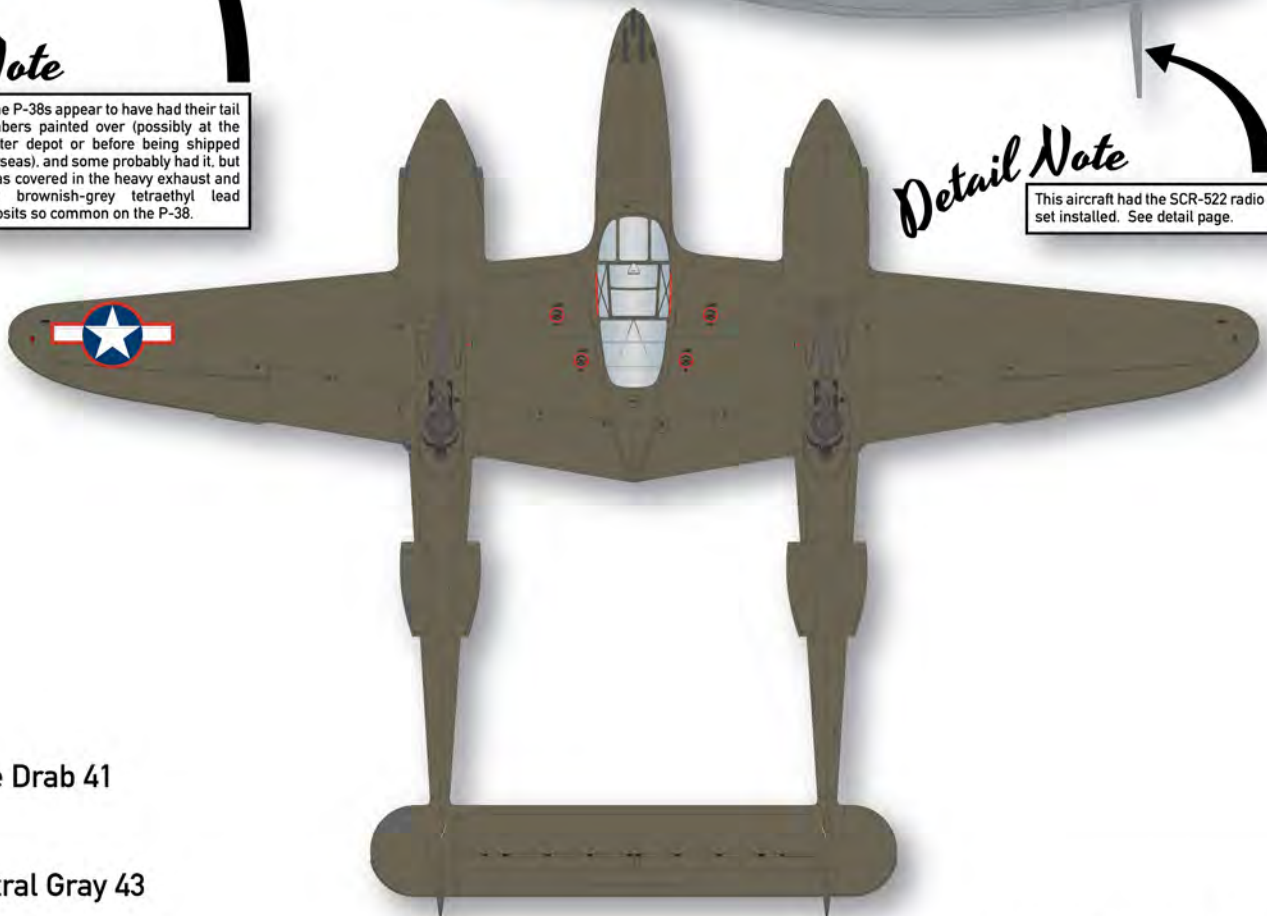

 Olive Drab 41

 Neutral Gray 43

Lieutenant Gerald L. Rounds completed his flight training at Kelly Field, Texas on 7 March 1942. In October he joined the 82nd Fighter Group before shipping out to North Africa. On 8 February 1943 Rounds made his first claim, a Bf 109 destroyed, while inverted in his P-38F. On 1 March Rounds scored his second kill while defending B-26s of the 17th BG from attacking 109s. Rounds finished out March with two more Bf 109s damaged before transitioning to the newer P-38G. On 21 May he claimed a Bf 109 as probable. Three days later he claimed another 109 destroyed after dropping a 500lb bomb on a hangar at Alghero airfield. On 5 July Rounds claimed his fourth kill, a Bf 109, during an escort mission to Gerbini, Sicily.

Up until this time Round's P-38G was coded 'CE' and named "Cadiz Eagle". Sometime after the invasion of Sicily the code was changed to 'CD' and the name and artwork changed to "Chicken Dit". Rounds scored his fifth and final kill on 11 September over a Bf 109 of JG.53. "Chicken Dit" was mortally wounded during this combat, and was written off after Rounds crash landed.

Gerald Rounds completed 82 missions before being transferred out of the 82nd at the end of September 1943.



A youthful looking Gerald Rounds poses in front of his P-38G "Chicken Dit". Note the tape over the shell ejection chute - dust was an ever-present enemy in the Mediterranean and North Africa.

Rounds's aircraft in her earlier guise as "CE" named "Cadiz Eagle". Note the lack of a visible serial - possibly overpainted or simply covered over with exhausts stains.



Detail Note

The upper canopy section opened upward on this aircraft.



Detail Note

She carried the iron sight post forward of the windscreen.

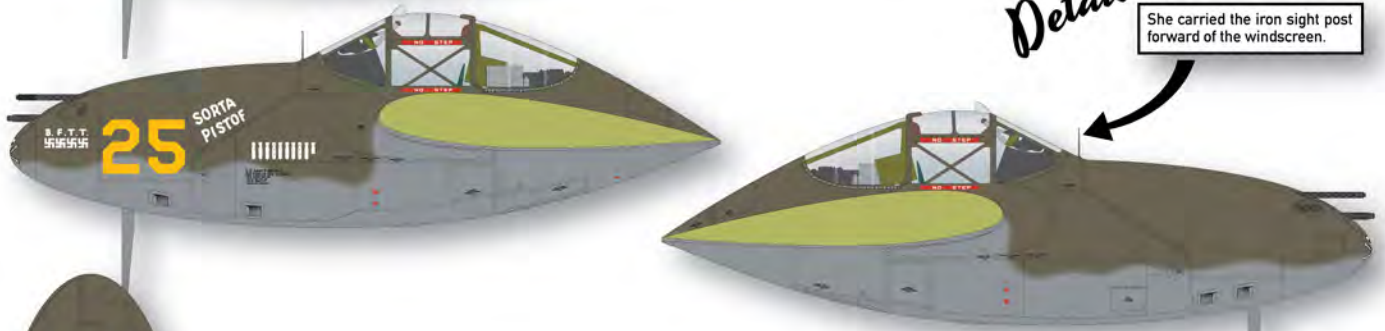

Detail Note

In many cases, the yellow (and later red and even later blue) outline on the insignias was not carried across the main gear door.

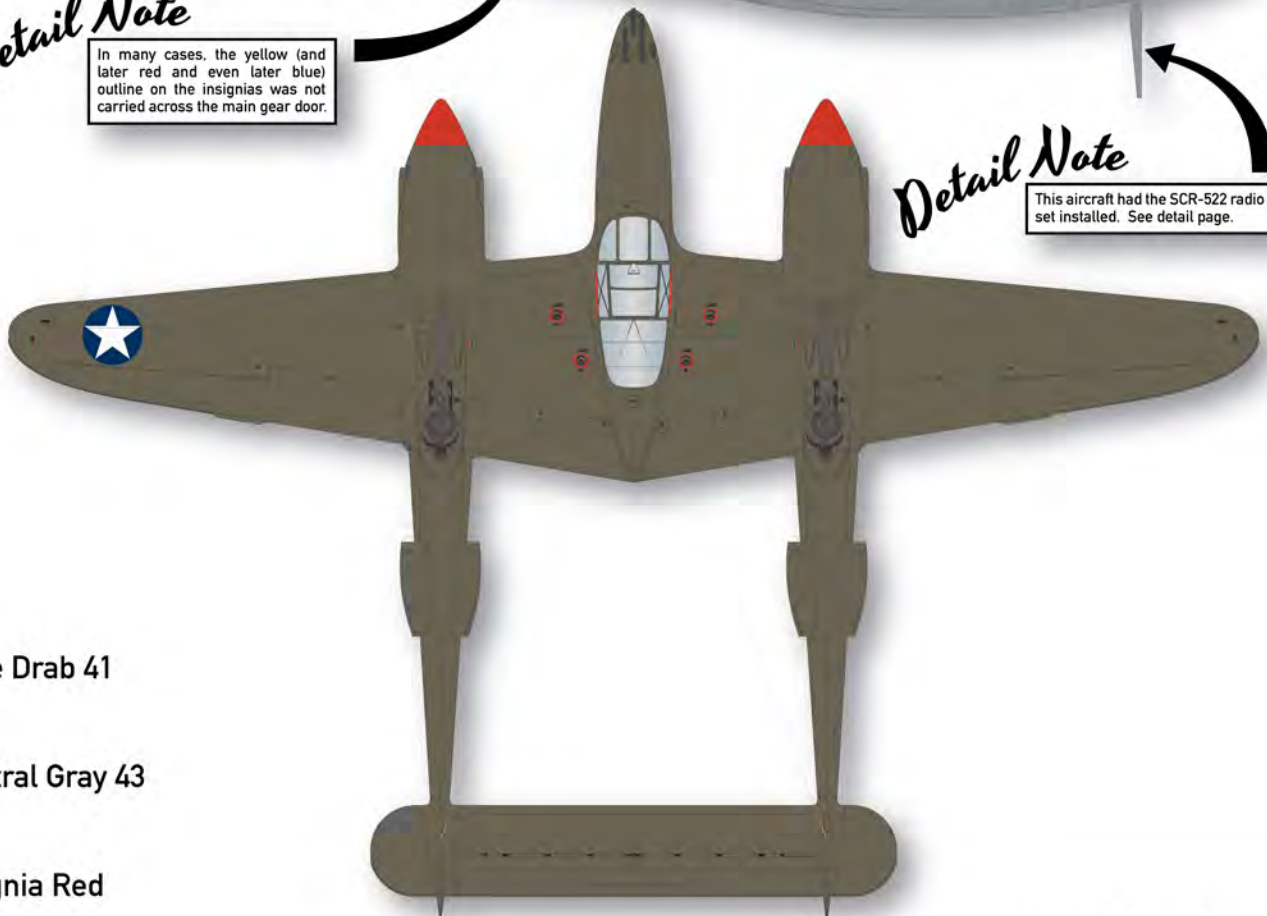

Detail Note

This aircraft had the SCR-522 radio set installed. See detail page.

-  Olive Drab 41
-  Neutral Gray 43
-  Insignia Red

On 18 July 1943 eleven P-38s of the 14th Fighter Group were assigned as top cover for air-sea rescue operations between Italy and Sardinia. Once this duty was fulfilled the Lightnings returned to base at low altitude and just happened to encounter a large formation of unescorted Ju 52 transport aircraft. A "turkey shoot" ensued with the P-38s claiming no less than 15 Ju 52s, though the Luftwaffe only counted between 9 and 11 missing aircraft. Lt Joel Hendrix was the leading scorer with four Ju 52s, as represented by 4 swastikas painted on the nose of his P-38G nicknamed "Sorta Pistof". We must admit, we're a little confused by the B.F.T.T. painted above the swastikas. Do these indicate a Bomber, a Fighter, and two Transport aircraft shoot down? Hendrix's claims were certainly all "T's"! Regardless, Hendrix's success was short-lived. On 4 August the 14th FG were escorting B-26s of the 17th BG to Italy when Hendrix flew a little too close to one of the bombers. A startled rear gunner fired at "Sorta Pistof" and the P-38 fell away. As he climbed back into formation at the rear of the bombers several rear gunners opened up on the friendly P-38 and sent it crashing into the sea, tragically ending Hendrix's young life.



Detail Note

The upper canopy section opened upward on this aircraft.



Detail Note

Bad Penny carried the iron sight post forward of the windscreen.

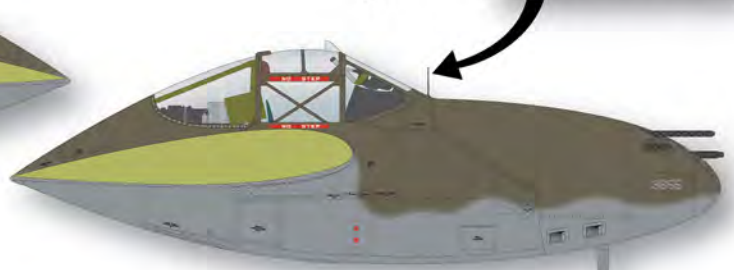

Detail Note

This aircraft had the SCR-522 radio set installed. See detail page.

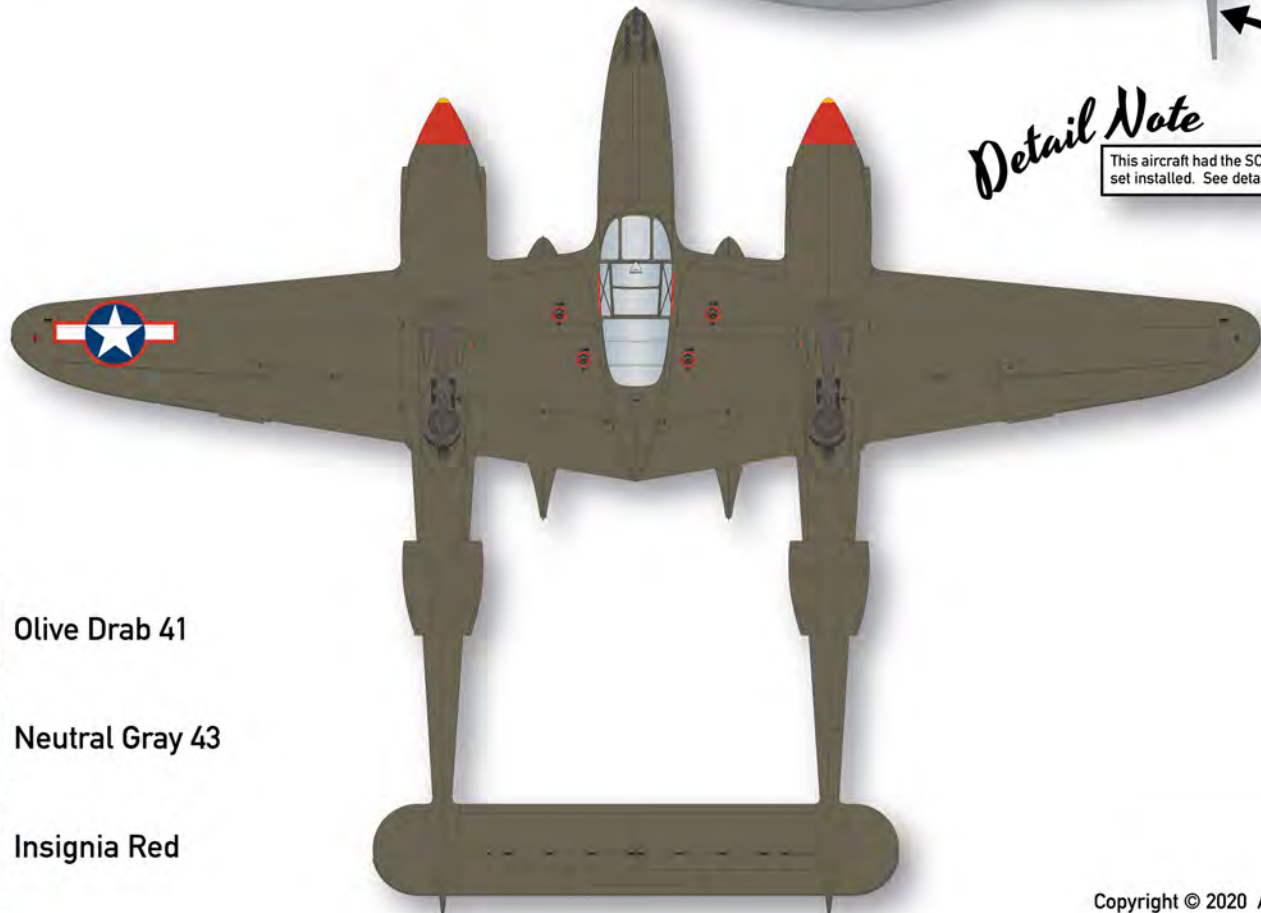

-  Olive Drab 41
-  Neutral Gray 43
-  Insignia Red

Louisiana native Captain Lloyd K. DeMoss flew "Bad Penny" as a member of the 49th Fighter Squadron. His P-38G is partly named for his alma mater, Centenary College of Louisiana, whose mascot name is "The Gentlemen". It is depicted showing his full score, at the end of his combat tour.

DeMoss's first confirmed kill was Bf 109 shot down on 9 May 1943 while escorting B-17s of the 97th Bomb Group on their way to bomb Palermo, Sicily. On 28 June, he claimed two Bf109s destroyed while escorting B-26s in raid on Sardinia.

On 27 August 1943, Capt. DeMoss shot down an Fw 190 north of Rome and claimed Bf 109 as probable, hence the question mark below his score. His score also shows three bomb marks representing the 14th Fighter Group's participation on Operation Corkscrew, the Allied bombing of the island fortress of Pantelleria between 8 May and 11 June 1943.

DeMoss returned to the States and became an instructor. He was killed in a crash near Entiwanda, California on 11 February 1944 when he lost control of his P-38.



DeMoss with "Bad Penny" in late 1943. Note the covered wheel hubs, the liberal coating of dust, and the camouflaged Mk. 6 160 gallon fuel tanks.



Detail Note

The upper canopy section opened upward on this aircraft.

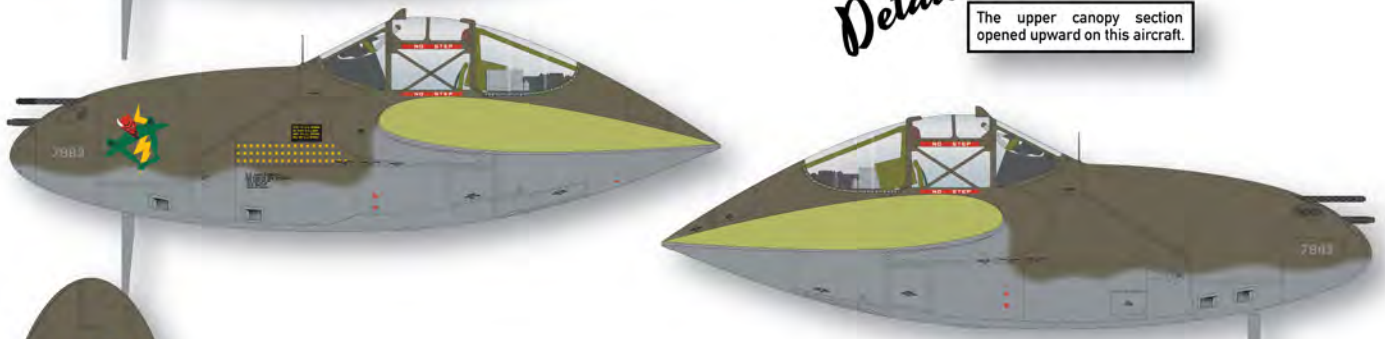

Detail Note

We have depicted her national insignias with slightly faded blue disks and darker blue overpainting of the previous red surrounds.

Detail Note

This aircraft had the SCR-522 radio set installed. See detail page.

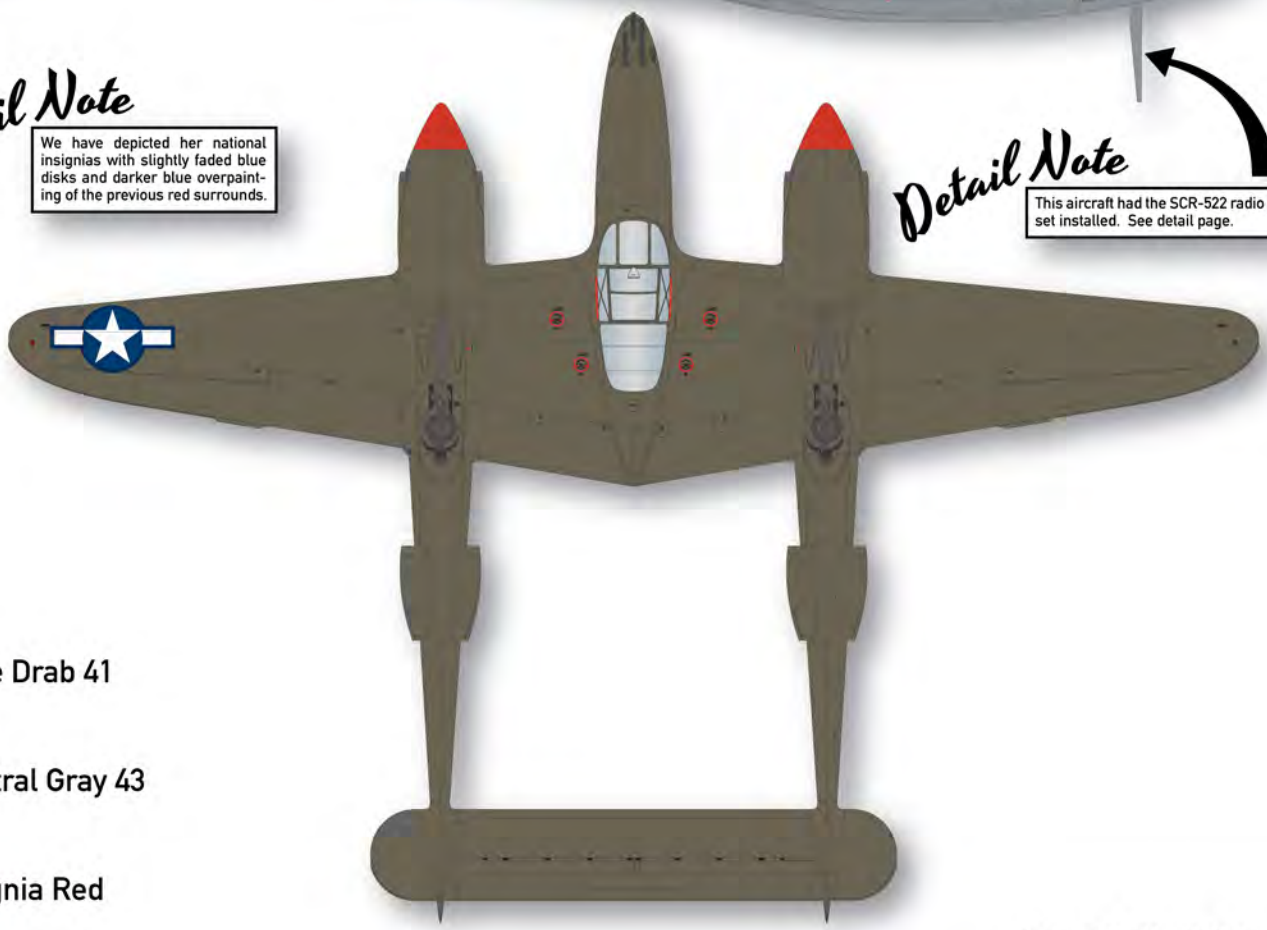

-  Olive Drab 41
-  Neutral Gray 43
-  Insignia Red



On 20 December 1943 2 Lt. Robert K. Seidman shot down three Bf 109s and damaged a fourth while flying a P-38 coded "ML" (Olynyk, "Stars and Bars", 1995, pg 548). The photos seen here of Seidman in front of a P-38G with the 49th Fighter Squadron's "Fork Tailed Devil" on the nose were taken the following day. Given the impressive number of missions on the scoreboard we believe "ML" was previously the favorite mount of Capt. Marlow J. Leikness (hence "ML") who used it to shoot down 5 Bf 109s between 3 July and 4 August 1943.

If this is indeed the same "ML" flown by Seidman during the December 20 mission, then it was responsible for eight enemy aircraft destroyed by the end of 1943.

Above and right. Bob Seidman poses in front of his aircraft coded "ML" with the fork-tailed devil nose art derived from the squadron's badge. Triolo airfield was an outlying field that was part of the enormous complex of fields around Foggia in southern Italy.



C-27286 A.C.

Detail Note

The upper canopy section opened upward on this aircraft.



Detail Note

Pat II carried the iron sight post forward of the windscreen.

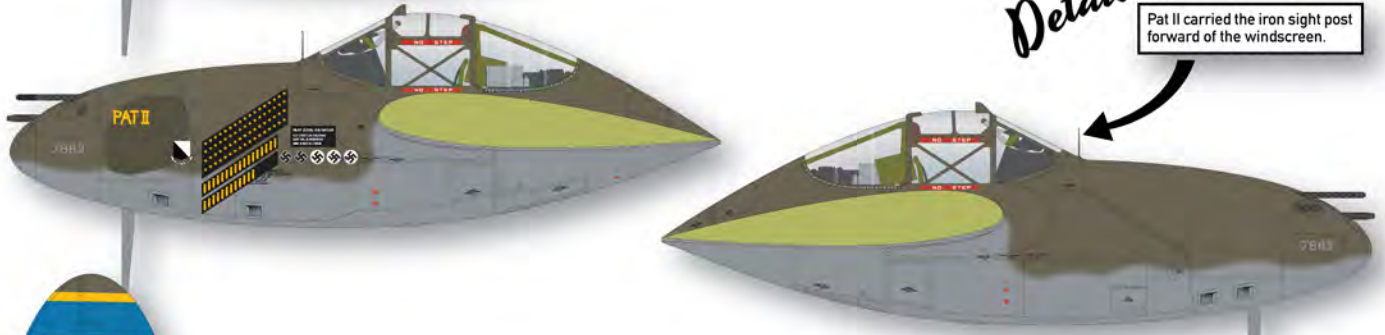

Detail Note

We have depicted her national insignias with slightly faded blue disks and darker blue overpainting of the previous red surrounds.

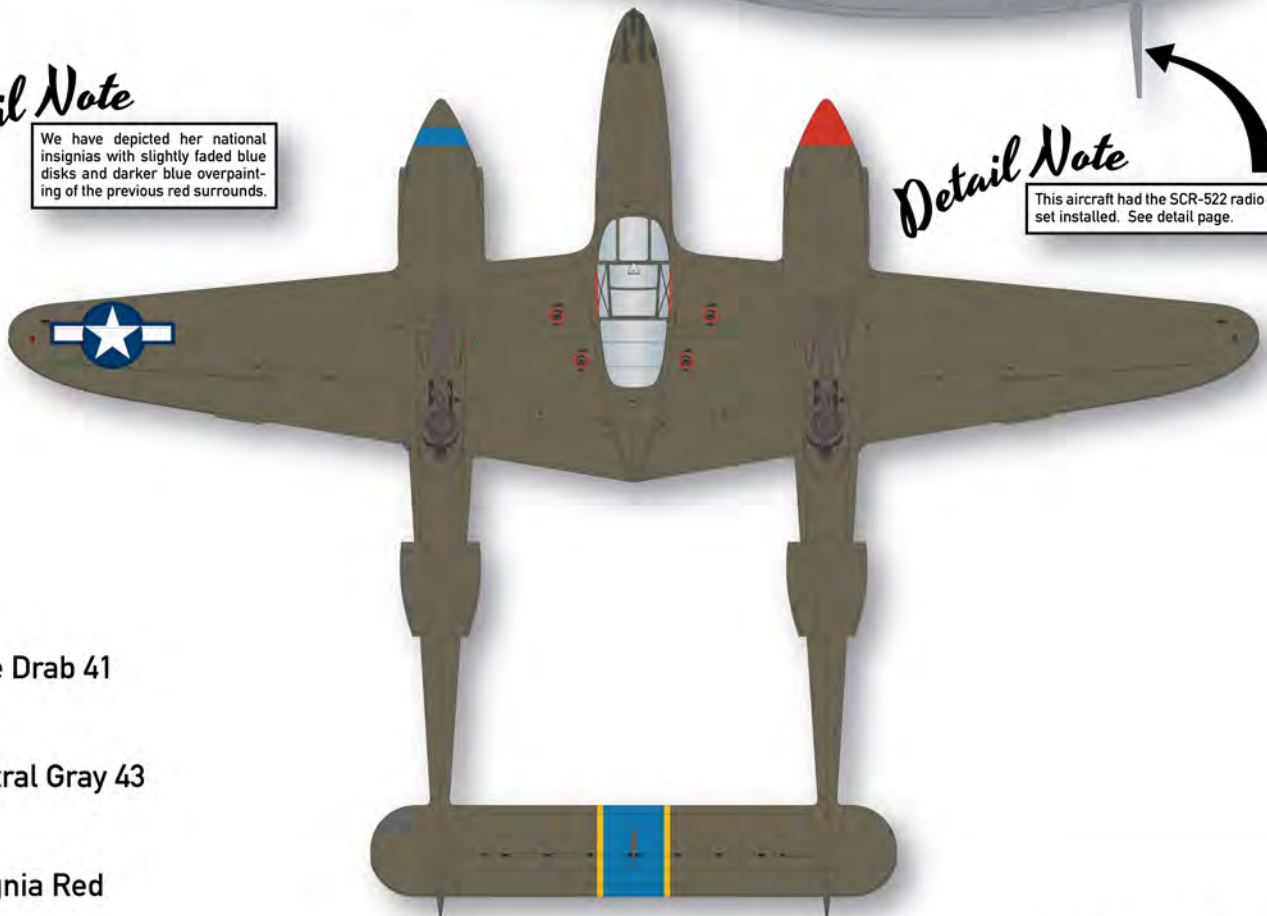

Detail Note

This aircraft had the SCR-522 radio set installed. See detail page.

-  Olive Drab 41
-  Neutral Gray 43
-  Insignia Red



Pat II displays her overpainted nose art, which we believe to have been the fork tailed devil portrayed under the entry for Seidman. Note her mismatched spinner trim colors.

A great view showing the later 49th FS blue and yellow trim colors, with the very unusual band on the horizontal stabilizer.



On the same day (20 December 1943) as 2 Lt. Seidman shot down 3 Bf109s (see P-38G 42-13449 page) the group's CO Lt Col Oliver B. Taylor claimed a Bf 109 shot down, one probable, and one damaged, all in a P-38 with the side number 56. But that's where the waters get murky. The same P-38 associated with "Ollie" Taylor over the years, 43-2527, #56, suffered a landing accident on 28 December while being flown by Major Arthur P. Reidhart and was struck off charge. We have reason to believe that Taylor was indeed flying 43-2527 #56 on the December 20 mission and that she was the first of three P-38s flown by him to be called "Pat".

This bombshell would mean that the famous "Pat II" is a different P-38 altogether. If so, then what was her true identity? After close scrutiny we believe that "Pat II" seen in the Spring of 1944 is the old faithful "ML" flown by Leikness and Seidman the previous year. Why do we think this? First, the impressive mission tally on the nose falls right in line with that of "ML". Second, there has been something on the nose painted out. We think the 49th FS emblem has been painted over and a more subtle 14th Fighter Group emblem put in its place. Finally, newly promoted 1 Lt Seidman was flying #56 when he shot down a Bf 109 on 7 April 1944. Taking all this into consideration we think that "ML" (with the fork tailed devil nose art), and "Pat II" are in fact the same airplane!

Although Lt. Col. Taylor is most associated with "Pat II", it turns out that Bob Seidman scored four out of his five aerial victories in it. Meanwhile, it is likely that Taylor only made one claim it, a probable Bf 109 on 25 February 1944. When the group began transitioning to P-38Js, Taylor took on #51 "Pat III" which he used to shoot down 2 G.50s and an FW190. Seidman sadly was KIA when his new P-38J with a Star of David on the nose was shot down by flak on 14 May 1944.

Detail Note

This aircraft had the side hinged upper canopy section. Use Tamiya parts H7 & H13.



Detail Note

Laven's aircraft appears to have carried the SCR-283 radio, with a single wire antenna leading from the anchor on the middle of the aft canopy frame to the center of the leading edge of the horizontal stabilizer. See detail page for more information.

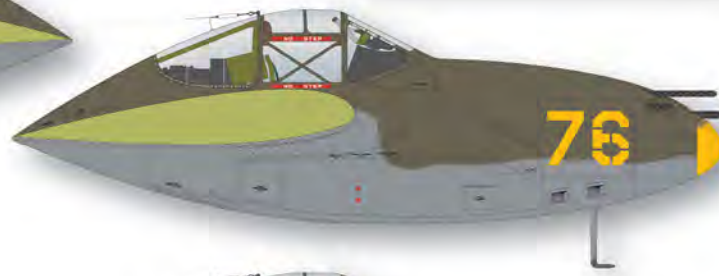

Note

Use this style of tail number for Laven's aircraft. The photo we needed appeared just after the main decal was printed (naturally).



Detail Note

Lockheed Mk 6 160-gallon tanks were camouflaged in Olive Drab and Neutral Gray, and as you can see in the photo on the next page, often quite dented up.

Detail Note

The gritty volcanic dust of the Aleutians tended to scour the paint from the back side of the prop blades, with more scouring further out toward the tip.

Detail Note

See notes on the details page regarding conversion of the P-38F/G into a P-38E.

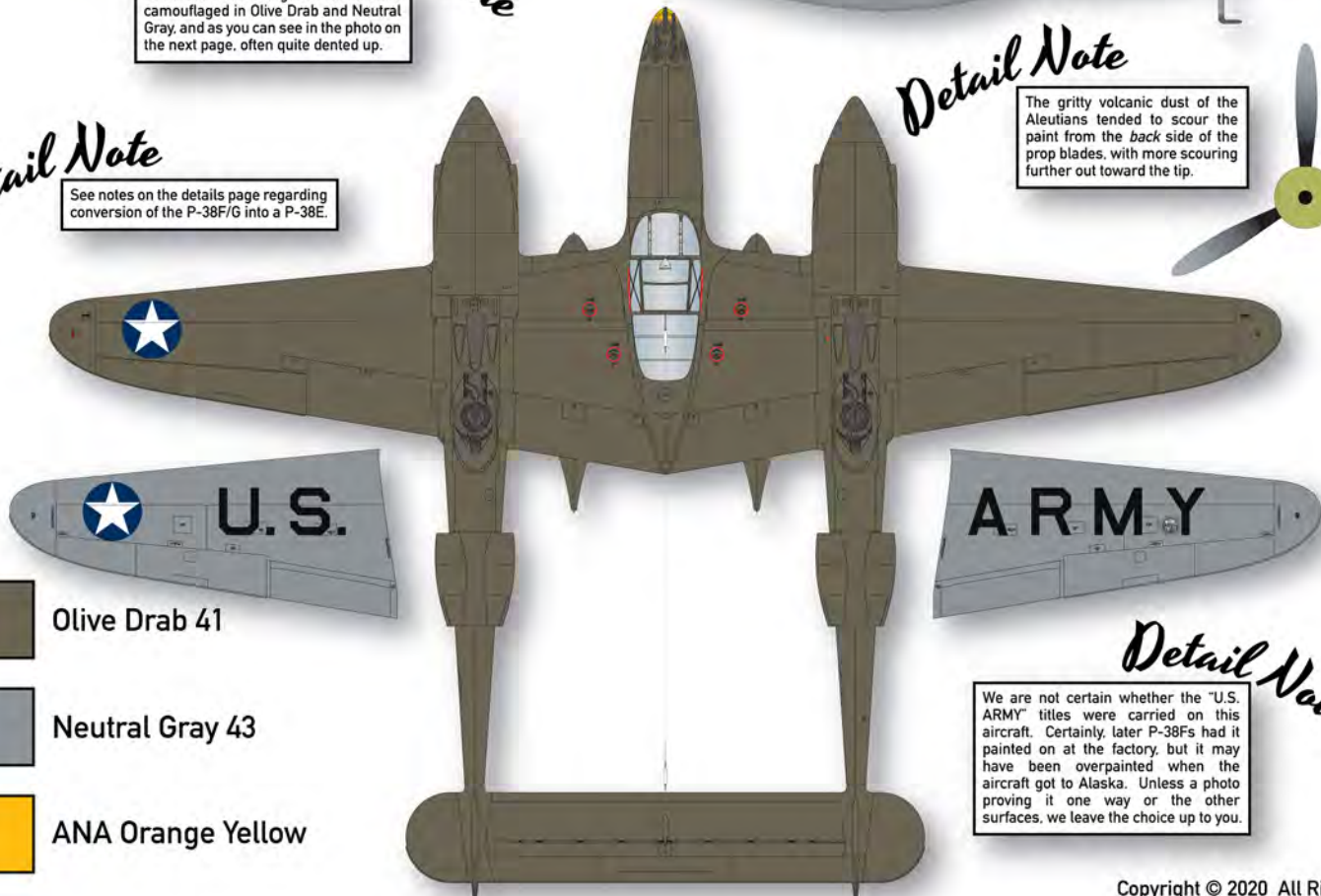

-  Olive Drab 41
-  Neutral Gray 43
-  ANA Orange Yellow

Detail Note

We are not certain whether the "U.S. ARMY" titles were carried on this aircraft. Certainly later P-38Fs had it painted on at the factory, but it may have been overpainted when the aircraft got to Alaska. Unless a photo proving it one way or the other surfaces, we leave the choice up to you.

Captain George "Choo-Choo" Laven, Jr. joined the 343 FG in Alaska in August 1942. On 3 September he participated in a nearly 9 hour mission to Kiska where he shared in the destruction of a Kawanishi 97 "Mavis" flying boat that was moored in the harbor. On 7 September Laven is credited with shooting down a Japanese observation biplane. On 13 February 1943 Laven shot down two A6M2-N "Rufe" observation seaplanes also near Kiska while flying "Itsy Bitsy" #76. Laven left the Aleutians in May 1943. Major Laven returned to combat in 1945 with the 49th Fighter Group. On 26 April he shot down a Kawanishi H8K "Emily" while at the controls of his personal P-38L-5-LO named "Itsy Bitsy II".

In December 1942 Laven flew "Itsy Bitsy" to a modification center in southern Alaska only to find out it wasn't operational. Undaunted Laven proceeded to fly on to one that he knew was open... in San Antonio, Texas where his family had relocated! On the return flight Laven flew by way of Calgary, Alberta where the two photos below were taken.



Scenic Amchitka circa 1943. Clearly a garden spot. The dark rectangles in the snow are the tents crews lived in. The runway was Marsden matting. The Aleutians are known for having some of the most severe climatic conditions on the planet. To try to fight a war in these conditions says a lot about the calibre of those who did it successfully.

Note OD overspray (?) at the top of the yellow nose cap.



Detail Note

This aircraft had the side hinged upper canopy section. Use Tamiya parts H7 & H13.



Detail Note

See notes on the next page regarding conversion of the P-38F/G into a P-38E.



Detail Note

Lockheed Mk.6 160-gallon tanks were camouflaged in Olive Drab and Neutral Gray, and as you can see in the photo on the previous page, often quite dented up.

Bonus markings!

Olive Drab 41 (faded)



Detail Note

The original blue disk insignia had the red border and white bars added during 1943, and it is likely the original position remained the same, with the red border thus slightly overlapping the leading edge of the aileron.

To build a later version of this aircraft, circa early 1944 at Alexai Point AAF on Attu, paint the spinners white, and use the blue bordered insignias from "Pat II", "The Sad Sack", or "Fork Tailed Devil". We originally thought that "Ground Hog" was painted white, but a late arriving photo seems to show it was yellow. Rather than delay release of the decal, we have provided the yellow as a laser printed piece that can be layered over the white decal. Be sure to trim the yellow close to the edges of the letters before application. Note that the nose cap has been repainted (or replaced with one from a newer aircraft) with fresh, darker OD with a different camouflage pattern.

We believe this whip antenna is associated with the SCR-535 radio. It is mounted slightly right of centerline. See details page.



Olive Drab 41 Neutral Gray 43 ANA Orange Yellow



We have to admit we know little to nothing about the history surrounding "Spirit of 76" or it's pilot Lt John Mackey. But the markings are too interesting NOT to put on our sheet. Her markings evolved over time, and amazingly, this very early model P-38E survived as a frontline combat bird at least into early 1944.

This aircraft and "Itsy Bitsy" were designed as RP-38Es on their factory applied data blocks. We're not sure what to make of that, since the "R" prefix technically meant the aircraft was restricted from combat duties, yet here they are fighting the Japanese in the Aleutians!

Note the hub caps on the mains, but the visible spokes on the nose wheel. See detail page for information on P-38E conversion from the P-38F/G.



At left is a later photo of "76" showing the "GROUND HOG" name applied, the white spinners, and the repainted or replaced nose cone. Note the tape over the gun ports.



At right is a view of Alexai Point AAF during the brief Alaskan summer, probably in 1943. Conditions were abysmal on the best of days.

When we started this project, we assumed that since the P-38 was so prolific and so widely used in every theater of war in which the US fought in WWII, there would be good references out there on the detail differences between the various versions. Boy, were we wrong! Sadly, there is an enormous amount of incomplete and downright wrong information published on this iconic airplane. Our collaborator John Clements has been enormously helpful in sorting out the differences, and we eagerly look forward to the book he is currently working on. As of this writing, probably the best book out there is Warren Bodie's "The Lockheed P-38 Lightning" published by Widewing Publications in 1991 (ISBN 0-9629359-0-5), although it covers more history and less nuts and bolts differences.

The P-38E was the first combat-ready version of the Lightning, and featured some notable differences, both from the previous P-38D and the later P-38F variants. Converting the Tamiya P-38F/G into a P-38E isn't difficult, as the illustrations below point out. Main points to note are the pitot tube on a longer boom under the nose, the absence of the ground-adjustable trim tabs that extended past the trailing edges of the ailerons, and the absence of the landing light under the right wing. Some references claim the E also had the earlier nose gear with a longer door and a different strut arrangement, but the photos below show that this is just one of the many inaccurate things you can find published on the Lightning.

The longer pitot boom, along with the SCR-522 radio set and antenna, are coming from Phase Hangar Resin Accessories (www.phasehangarresin.com).

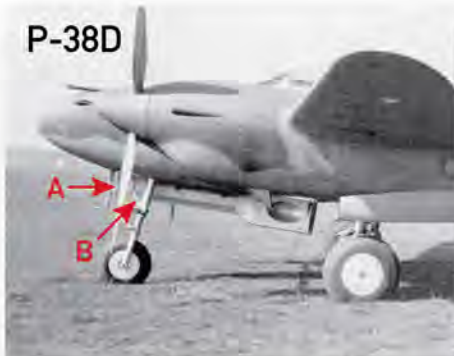

P-38D



P-38E



P-38F

Note that the nose gear door on the P-38D and earlier versions was much longer, and extended further forward than the strut itself (A). The arrangement of the drag strut (B) was also completely different. The arrangement on the P-38E and subsequent models was the same.

P-38E



P-38F & later



A view of one of our subjects showing the longer pitot boom below the nose of the P-38E. This view also shows the whip antenna which we believe may be a variant of the SCR-522 antenna seen on later aircraft. Since the pitot boom of the P-38E was located in approximately the same place as the AN-104-A antenna, this one may have been a substitute.





Detail Note

This aircraft had the side hinged upper canopy section. Use Tamiya parts H7 & H13.

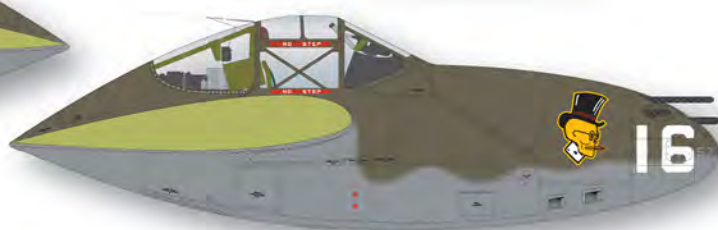

Detail Note

This aircraft had the side hinged upper canopy section. Use Tamiya parts H7 & H13.

Detail Note

Lockheed Mk.6 160-gallon tank was camouflaged in Olive Drab and Neutral Gray, and only carried on the left hand side in the photo on the next page.

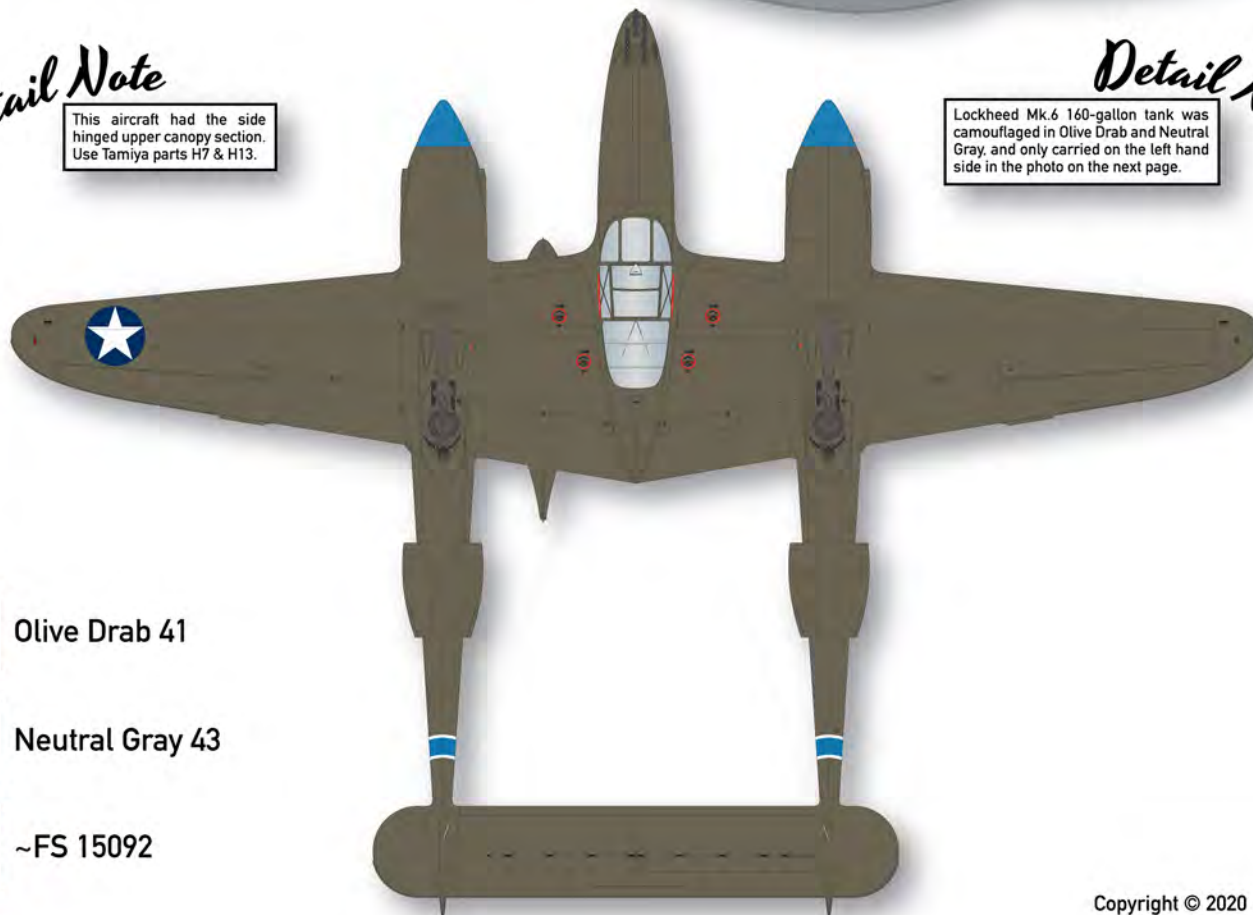

-  Olive Drab 41
-  Neutral Gray 43
-  ~FS 15092

Lieutenant Bob Faurot was initially assigned to the 39th Pursuit Squadron, 31st Pursuit Group at Selfridge Field, Michigan. In 1940 he was chosen from small group of volunteer American Air Officers to go to England and fly as observers with the Royal Air Force. While in England he flew Spitfires and Hurricanes with 303 and 306 Polish Squadrons. He was awarded the Polish Combat Medal before being ordered back to the United States in July 1941.

Captain Faurot was the first pilot to score a victory in a P-38 with the 5th Air Force when engaged a Japanese fighter taking off from a Lae. As he passed over the enemy airstrip he quickly released two 500 pound bombs so he could prepare to dogfight. The bombs exploded in the water at the end of the airstrip. Just as the Japanese aircraft was taking off, it flew through the explosion, winged over, and crashed into the water. 5th AF Commander General George Kenny personally presented Faurot with an Air Medal and kidded Faurot. "I want you to shoot them down, not splash water on them!"

Faurot's personal P-38 was #26 tail number 42-12633. He was flying it on the mission to Lae mentioned above, as well as when he was killed in action in the Battle of the Bismark Sea 3 March 1943, defending a flight of B-17s.



Bob Faurot poses in front of his ship on 20 January 1943.

Faurot's aircraft parked on one of the fighter strips around Port Moresby in early 1943 before her nose art had been applied. Points to note are the uncovered wheel hubs (nose and main), the single 160 gallon Mk.6 tank mounted under the left wing, and her generally unweathered appearance. When she was lost in early March '43 she wasn't very old, and thus hadn't had a chance to become terribly weathered.



Detail Note

This aircraft had the side hinged upper canopy section. Use Tamiya parts H7 & H13.



Detail Note

Lockheed Mk.6 160-gallon tanks appear to have been painted a generic light grey, noticeably lighter than Neutral Gray, and were widely used in the SWPA at this time.

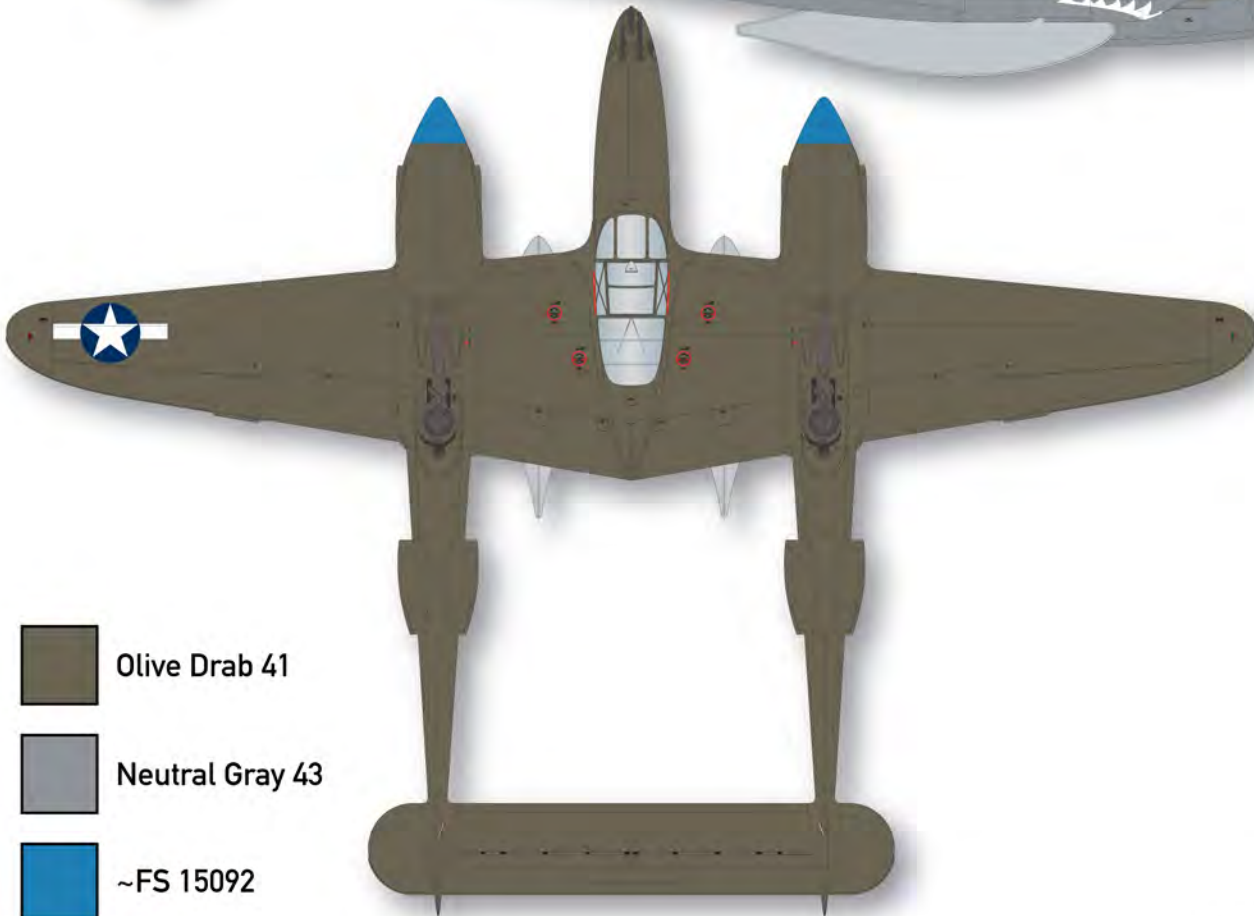
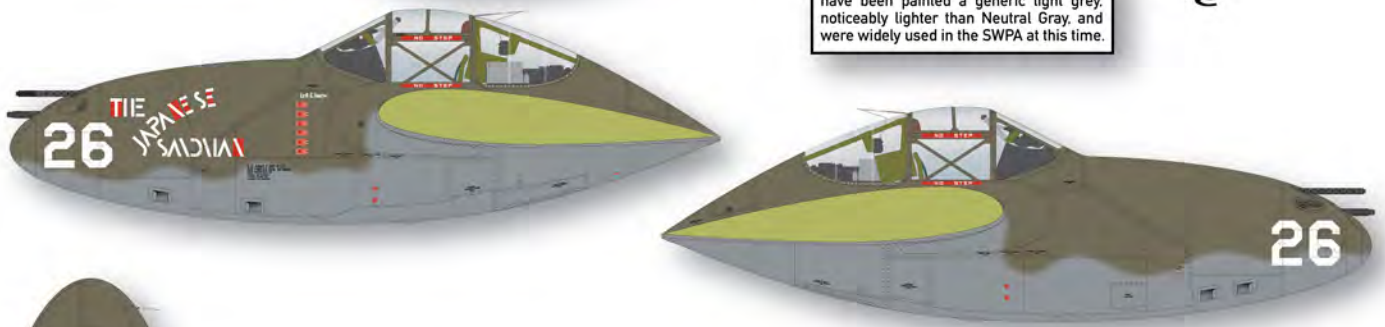

-  Olive Drab 41
-  Neutral Gray 43
-  ~FS 15092



First Lieutenant Richard E. "Snuffy" Smith made his first claim in a P-38 on 6 January 1943 when he shot down a Ki-43 Oscar. Smith's first claim in P-38F-5-LO, 42-12640 #26 on 3 March, another Oscar destroyed. On 12 April Smith shot down a G4M Betty (though flying a different P-38). By July #26 carried the name "The Japanese Sandman." On the 21st Smith in #26 shot down two Ki-61 Tonys, bringing him ace status. Two days later he bagged another Oscar, but this was the last claim he made in "The Japanese Sandman." On 22 September claimed one A6M Zeke kill and another damaged in his P-38H-1-LO, named "Japanese Sandman II". These were his last claims of the war, bringing his total to seven enemy aircraft destroyed in the air, plus one damaged, four of those in the original "Sandman."

Smith's first aircraft named "The Japanese Sandman" had unique, and very inventive lettering. Careful scrutiny of the photo shows what we believe to have been red behind several of the letters that has not been documented before.

The photo below shows Smith in front of his aircraft in early 1943 before the name had been applied.



Detail Note

The upper canopy section opened upward on this aircraft.



Detail Note

Phoebe carried the iron sight post forward of the windscreen.

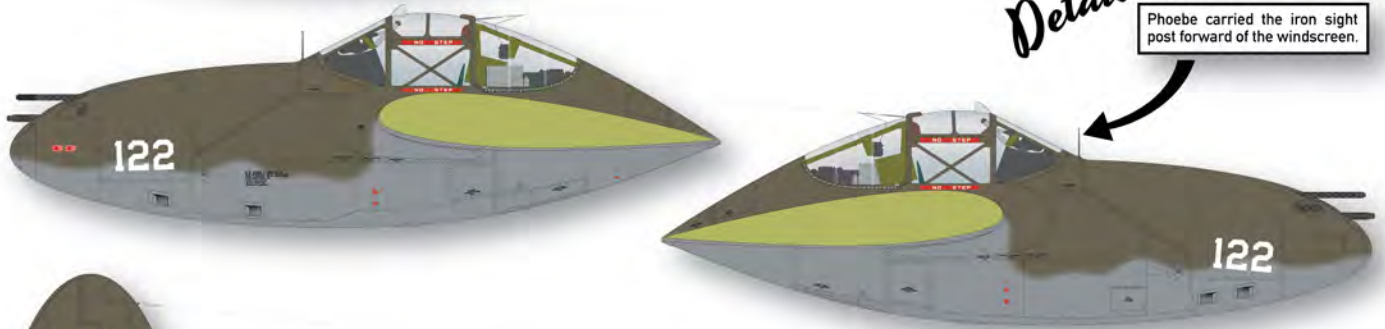

Detail Note

Serial number and left/right marked on prop blades.

Note angle of nose number. The right side appears slightly more angled down than the left side.

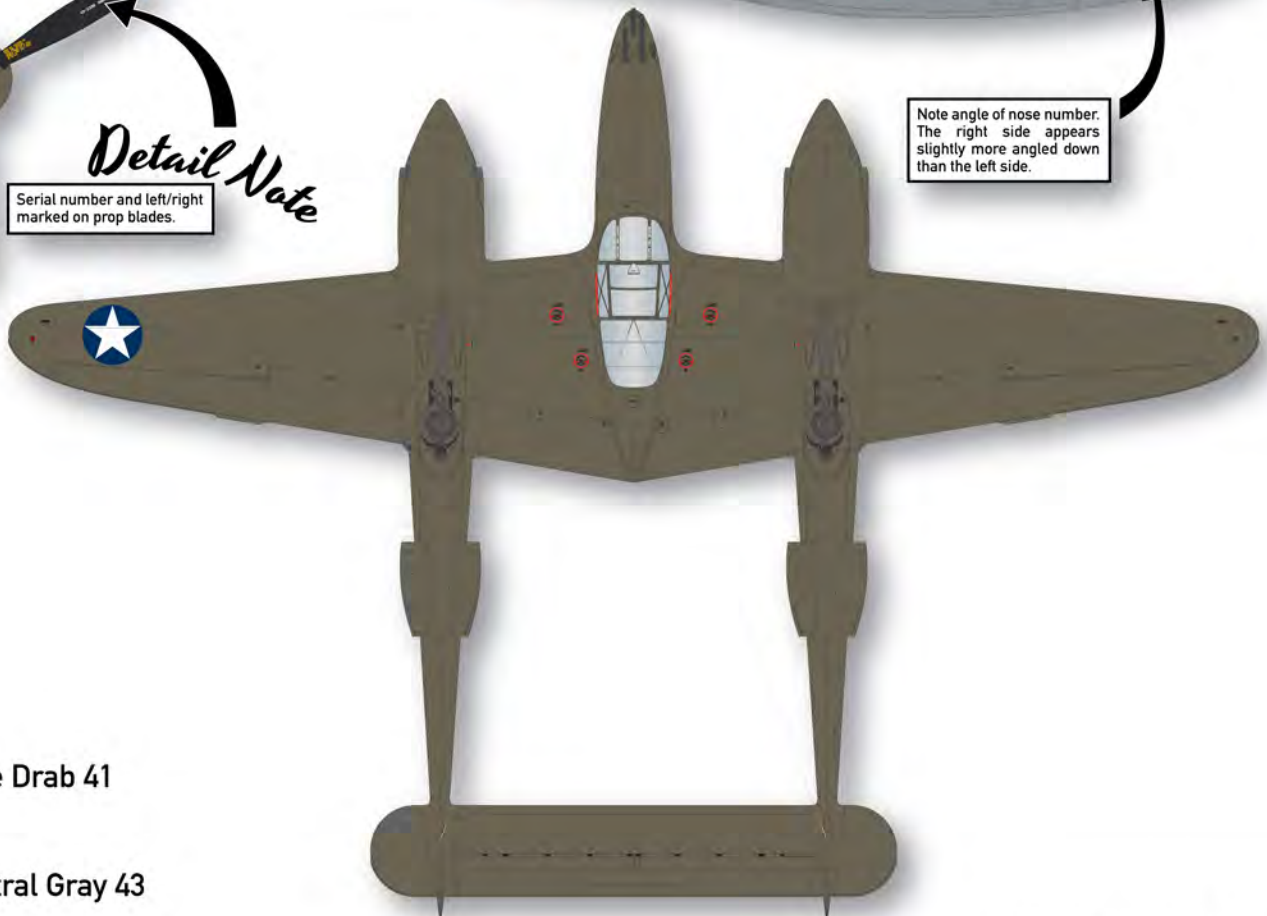

Olive Drab 41



Neutral Gray 43

Capt. Tommy Lanphier was selected to participate in the now-famous Yamamoto mission in April 1943. Initially, Lanphier, Rex Barber, and Lt. Besby Holmes each claimed a single G4M Betty shot down. Lanphier claimed that the Betty he bagged was Yamamoto's, and for many years that claim stood. However, new information revealed in 1969 by Admiral Ugaki, a Japanese survivor of the airplane Holmes shot down, indicated that only two Bettys were shot down that day. Since all sources agreed that Holmes had sent one into the sea, Barber and Lanphier could only have shared the second. Both pilots stuck to their claims of having shot down Yamamoto, and the feud persisted for many years. In 1991 the USAF officially allocated one-half credit to each.

Many historians and researchers believe that Barber had the better claim for having shot down Yamamoto. Besby Holmes wrote that during the battle, it was his impression that Barber had shot down Yamamoto. To his dying day, Lanphier maintained that he had scored the Yamamoto kill, with gunfire from his P-38 blowing off the Betty's right wing. We will probably never know for certain exactly what happened that day, but it makes for a good story!



Two photos showing Lanphier's rather plainly marked "Phoebe". Note that the "122s" on the nose were applied at an angle to the longitudinal axis of the aircraft. Also note her uncovered nose wheel hub and covered mains. Otherwise she was a very bog standard looking P-38G.



Detail Note

The upper canopy section opened upward on this aircraft.

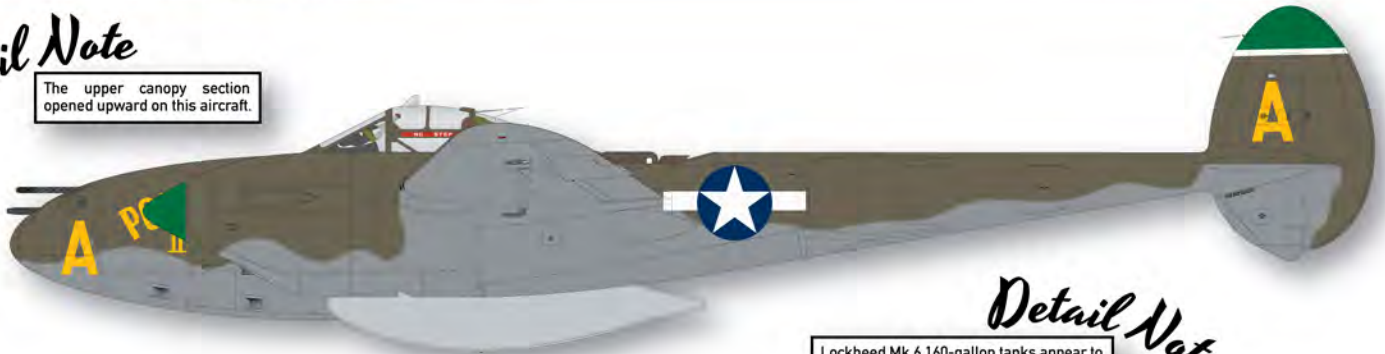

Detail Note

Lockheed Mk.6 160-gallon tanks appear to have been painted a generic light grey, noticeably lighter than Neutral Gray, and were widely used in the SWPA at this time.

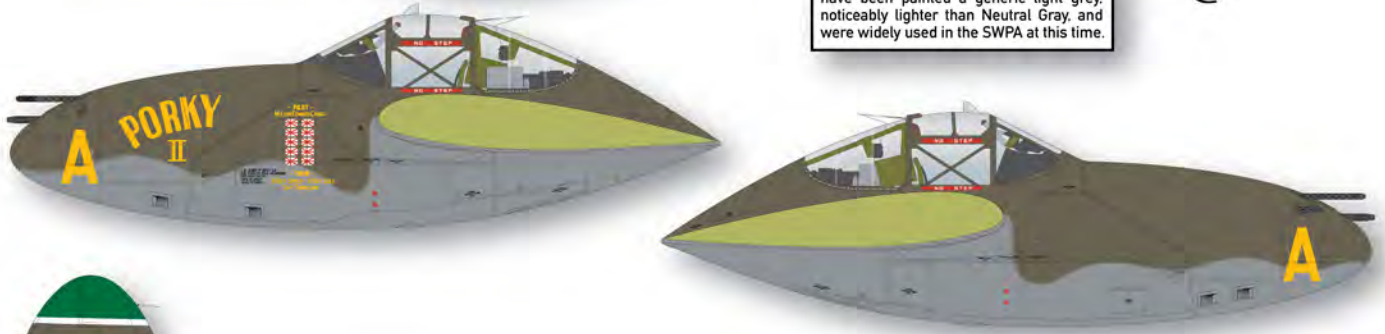

Oops!

We just plain neglected to provide the 2" wide white stripes across the vertical tails. In 1/48, those stripes are 1.1mm (0.04") wide. Mask when you paint the green tail tips.

Just one of many inaccurate pieces of information you can find published on the P-38 is that the P-38H had the same oval section supercharger intakes as the earlier versions. This closeup of "Porky II" proves that the H-1 and subsequent had the larger intake fairings. These are available from Quickboost (for the Tamiya P-38F/G) and are included in the Tamiya P-38H boxing.



-  Olive Drab 41
-  Neutral Gray 43
-  ~FS 14090

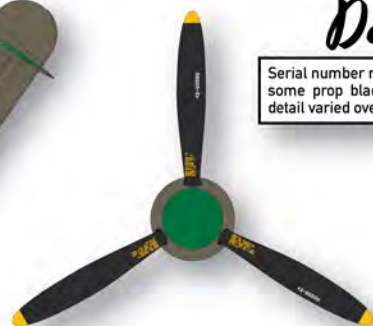
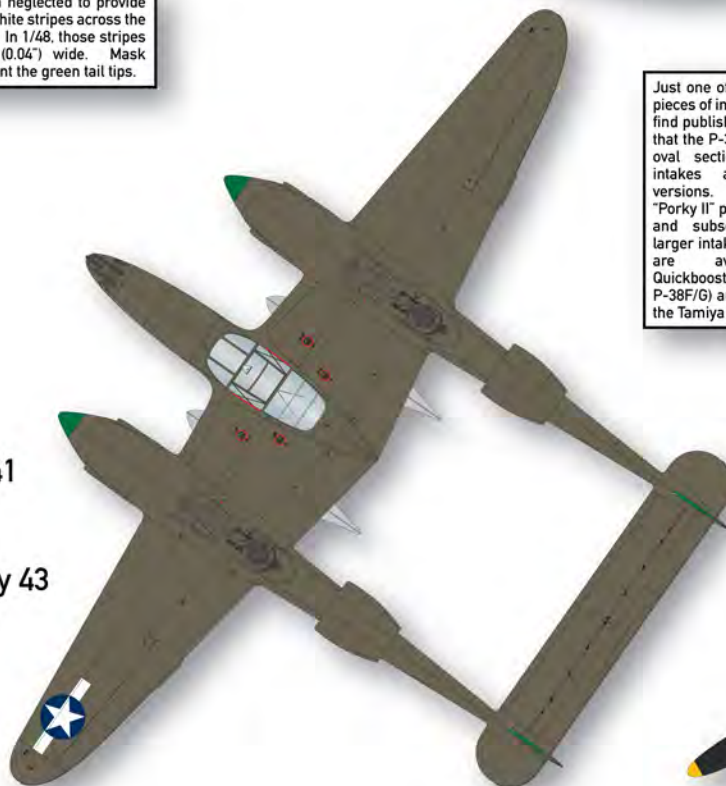

Detail Note

Serial number marked on some prop blades. This detail varied over time.



"Porky II" showing her covered nose, and uncovered main wheel hubs. Again, note the light grey Mk.6 tanks - noticeably lighter than the Neutral Gray belly of the aircraft. Cragg's ship appears to be fairly well maintained (given the conditions...). Note the ubiquitous light brownish grey exhaust and tetraethyl lead stains on the boom and the vertical fin.

Major Ed "Porky" Cragg shot down 15 enemy aircraft during WWII, ten of those while at the controls of his personal P-38H-1-LO serial 42-66506 named "PORKY II". Cragg made his first claims in "Porky II" on 23 July 1943 when he shot down an A6M Zeke and a Ki-61 Tony. Cragg repeated that same feat on 20 August. On 4 September he claimed two more Zekes, and on 24 October bagged two Hamps. Cragg switched to another P-38 in November but was back in "Porky II" on 22 December when he shot down another Ki-61 Tony. On Boxing Day 1943 Major Cragg shot down a Ki-44 Tojo, but he and "Porky II" were reported MIA.

Our decals allow you to depict "Porky II" from the September 1943 through August 1944 period when she sported 5, 6, 8, or 10 kills on the nose. When Cragg began flying "Porky II" again in December the personal markings had been repainted in a different style.





Detail Note

The upper canopy section opened upward on this aircraft.



Detail Note

Note the close spacing between the "1" and the "3" on the left side of the nose only. Use appropriate decal for this position.



Lieutenant "Fran" Lent was flying his personal P-38H-1-LO, 42-66550, named "T.Rigor Mortis" for his first eight aerial victories. Lent shot down a Hamp on 18 August 1943. Three days later he claimed a "TE fighter" (Olynk, "Stars and Bars" p. 339) and a Zeke both destroyed. On 15 October he shot down a Val dive-bomber and two Zekes. On 24 October he bagged a Ki-61 Tony and on 2 November he claimed a Zeke destroyed and probable. It is likely that Lent was still flying "T-Rigor Mortis" when he shot down a G4M Betty on 16 December. After having upgraded to a new P-38J by 31 March 1944, Lent brought his final score to 11 when he shot down two more Zekes.



Detail Note

The upper canopy section opened upward on this aircraft.



Detail Note

In common with many aircraft the CBI Theater, Little Butch II had a large ADF loop antenna mounted on what appears to be a zinc chromate primed plinth on the aft part of the fuselage pod. You're on your own for scratching that up from your spares box!

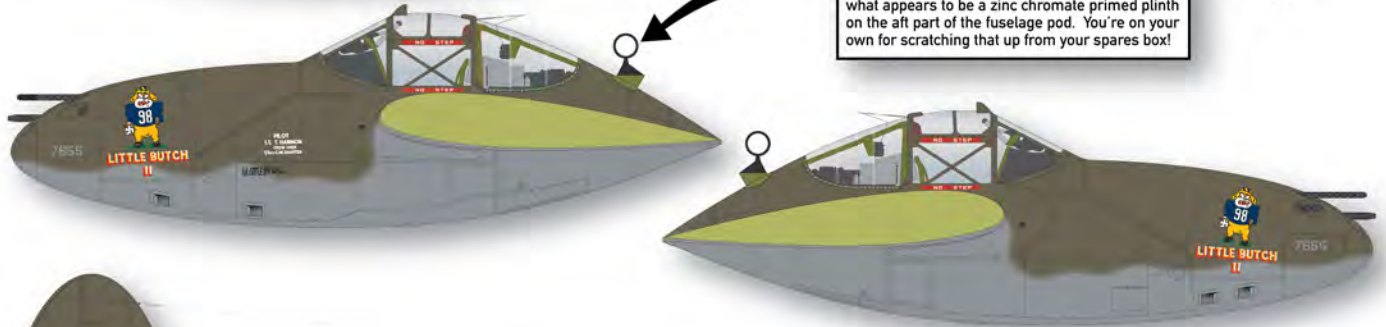

-  Olive Drab 41
-  Neutral Gray 43
-  Insignia Red

Lieutenant Tom Harmon was an All-American tailback and Heisman Trophy winner at the University of Michigan and also happens to be the father of television heartthrob Mark Harmon. On 30 October 1943 Lt. Harmon participated in a long range mission to bomb Kiukiang Harbor. He claimed two enemy fighters shot down but was forced to bail out of his crippled P-38. He evaded capture and returned to duty a month later. As good as that story is, this P-38 is not that P-38. According to several sources the P-38 Harmon was flying on 30 October was 42-13415. This P-38G-10-LO named "Little Butch II" is 42-13221. It is possible that '221 was a replacement for '415, or possibly even vice-versa.

The 449th Fighter Squadron was formed from elements of the Northwest African Training Command, including the 1st, 14th, and 82nd FGs in a bid to reinforce the AAF's presence in China. This would be the P-38's first appearance in the CBI, and the newly formed squadron was christened "Squadron X" to keep its identity secret. A long overland ferry route took the squadron to Kunming, China in August of 1943.

On arrival in China, no squadron markings were carried. When the 449th was absorbed into the 51st Fighter Group, aircraft were given squadron numbers in the low 300s. Since Harmon's story is so compelling, and since we had good photos of the nose art on both sides of his ship, we decided to go a little way out on a limb with our decal. We can't prove that his aircraft carried the side number '304', but it is as likely as anything. The style of number conforms to other aircraft in the squadron at this time. Your model might even be accurate without it, so we'll leave the choice to you.



Harmon posing with his "Little Butch II". As a player for Michigan, it was natural that he used his jersey number and Michigan's maize & blue colors for his nose art!



A curious group of Chinese soldiers inspect a 449th FS P-38 at Kunming. The Lightning was new to their part of the world, and undoubtedly attracted attention wherever it was seen. Note the three digit side number, the prominent ADF loop antenna and its mount aft of the cockpit, and how the crushed stone had already begun to scour the paint from the back side of the prop blades.



Detail Note

This aircraft had the side hinged upper canopy section. Use Tamiya parts H7 & H13.

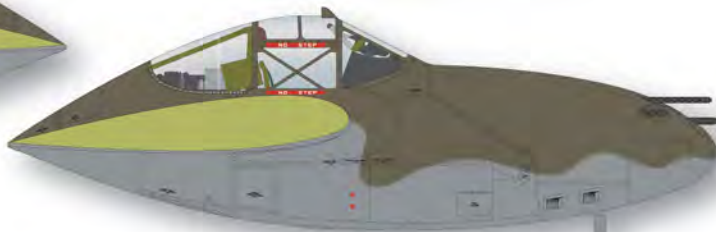
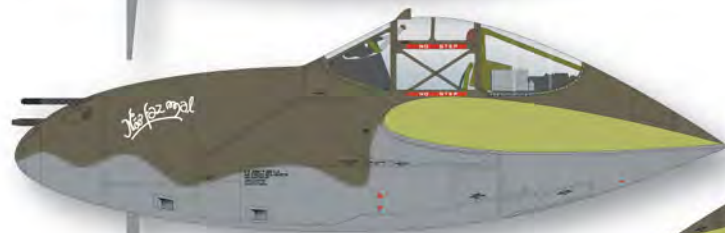

Detail Note

This aircraft had the SCR-522 radio set installed. See detail page.

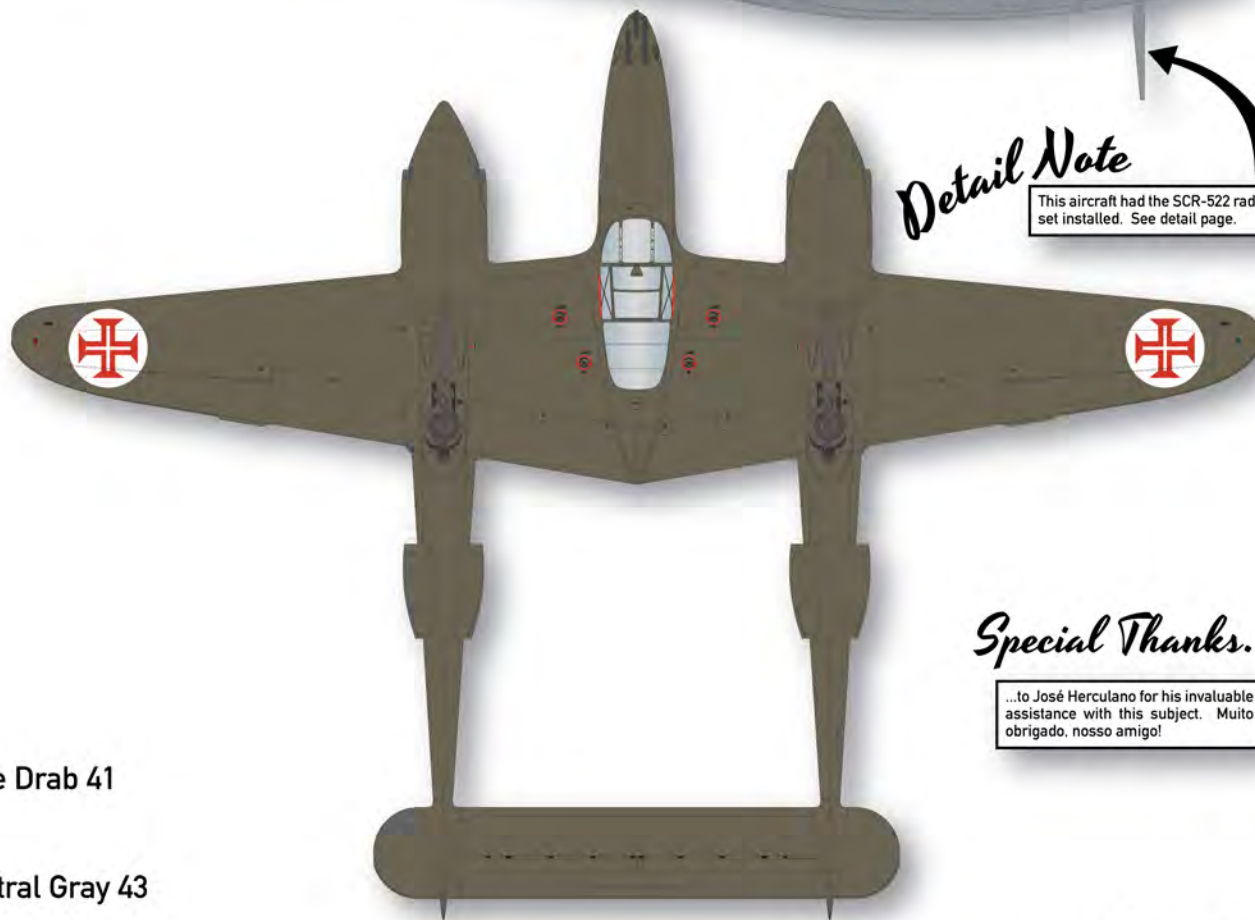

Special Thanks...

...to José Herculano for his invaluable assistance with this subject. Muito obrigado, nosso amigo!

 Olive Drab 41

 Neutral Gray 43

Probably no other single P-38 has ever ignited as much controversy as this one! There is a lot that we know about her, but as you will read, a lot that we don't, which only makes the mystery that much more interesting.

In November of 1942, elements of the 1st Fighter Group were making their way from England to North Africa, many by way of Portuguese airspace. On 15 November, Capt. Jack Ilfrey landed his P-38F-1-LO 41-7587 at the Lisbon airport after experiencing a fuel shortage.

Ilfrey was questioned by Portuguese officials, and his aircraft was refueled. The Portuguese insisted on being briefed on how to operate the aircraft, much to Ilfrey's consternation. But, as he was a guest in their country, and they had the guns (even though they were sympathetic to the Allied cause), Ilfrey reluctantly agreed. A Portuguese pilot stood on the wing as Ilfrey sat in the cockpit briefing him on the Lightning's instruments and controls. Then Ilfrey saw his chance, goosed the throttles, blew the Portuguese officer off the wing, and made his escape across the field.

At about this same time, another P-38, this time our subject aircraft, P-38G-1-LO 42-12738, flown by Capt. James A. Harmon, landed at Lisbon. Wisened from their previous experience with Capt. Ilfrey, Harmon was escorted away from his aircraft and the aircraft was secured inside a hangar.

On 21 November Capitão Costa Macedo ferried the P-38 from the Lisbon civilian airport to Sintra Air Base outside the capital. The P-38 languished at Sintra until 17 June 1943, when it was ferried to Ota Air Base, northeast of Lisbon. Ota was the home of Portugal's "OK Flight", operating a collection of Bell P-400 and P-39 Airacobras. There it was given an "OK" flight code and the individual letter "T", and the serial number 335 (later changed to 300). At some point, the inscription "Não faz mal," which loosely translates as "It's harmless" was applied in white on the left side of the nose.

The Lightning became more of a curiosity than an actual warplane while in Portugal, and its condition deteriorated rapidly. Fuel leaked from the wings, and the fuel pump and carburetor membranes broke down due to the high percentage of benzene in the aviation gasoline supplied to Portugal by the Dutch in the East Indies.



Capt. Harmon's ship shown, probably at Ota Air Base, sometime in late 1943. Owing to a complete lack of spares support and inferior fuel, the aircraft rarely flew by this point, and, sadly, was scrapped sometime in 1944. See next page for thoughts on the colors.

This is where the story gets... interesting... Color photography was virtually unheard of in Portugal during WWII. Photography of Portuguese military aircraft was frowned upon in general, and thus almost no photos of "Não faz mal" are known to exist, and all that do are black & white. What is known is that when the aircraft arrived in Portugal, it was finished in standard USAAF Dark Olive Drab and Neutral Gray. But as you can see in the photos, it *appears* that the Portuguese applied some kind of a two-color camouflage to the upper surfaces.

Portuguese researchers and modelers have almost literally come to blows over the interpretation of this photo (by far the highest quality one known). Those on one side swear the aircraft was two colors on top, and the other side swears just as fervently that it was only ever painted USAAF Olive Drab. You have to admit that it does *appear* that there is a second color, and what can be discerned of the pattern (if there was one) would make sense, since it would have been applied to cover over the USAAF markings, none of which is in the least visible.

Okay, you ask, so what color was it, if it was two colors? Well, that's a really good question. Portugal was operating Spitfires and Hurricanes in RAF Dark Earth, Dark Green, Ocean Grey, and Medium Sea Grey. They also operated P-39s in DuPont equivalent RAF colors as well as USAAF OD/NG. Whether any stocks of those colors were to be had in Portugal is another matter, and perhaps we're simply seeing some local color.



We will admit to having absolutely no idea of what we're seeing in the photo on the previous page. Does it actually represent a two-color camouflage pattern on this aircraft, or is it simply patchy fading of the Olive Drab top color? We tend to come down on the side of some Portuguese-applied color having been used to paint out the USAAF markings and her 1st FG markings (makes sense, right?), but as to what color it might have been, well, that's anyone's guess. Owing to wartime shortages of just about everything in Portugal, it seems likely to have been a locally procured color, as stocks of the actual camouflage paints used on Portugal's US and British supplied aircraft were essentially non-existent. So we say, have fun with this one! Was it something akin to Dark Earth? Or something akin to Ocean Grey? Or something else entirely?



-  Dark Earth?
Ocean Grey?
-  Olive Drab 41
-  Neutral Gray 43



SCR-283

Unique among our subject aircraft, George Laven's "Itsy Bitsy" appears to have been fitted with the SCR-283 command radio set. This was the first type of radio fitted to P-38s, and was largely replaced early in the war. The SCR-283's receiver and transmitter units can be seen in the photo at left. This set used a single wire antenna that stretched from a mount on the aft canopy frame, straight back to the leading edge of the horizontal stabilizer. It had prominent insulators on each end, and the lead went through a hemispheric insulator in the aft canopy.

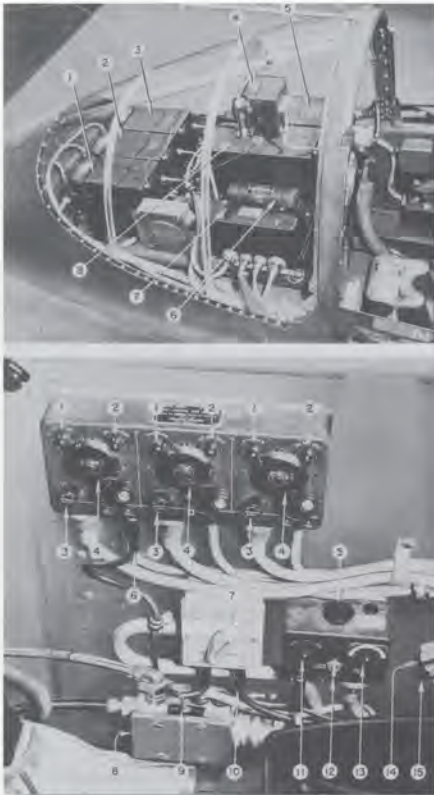
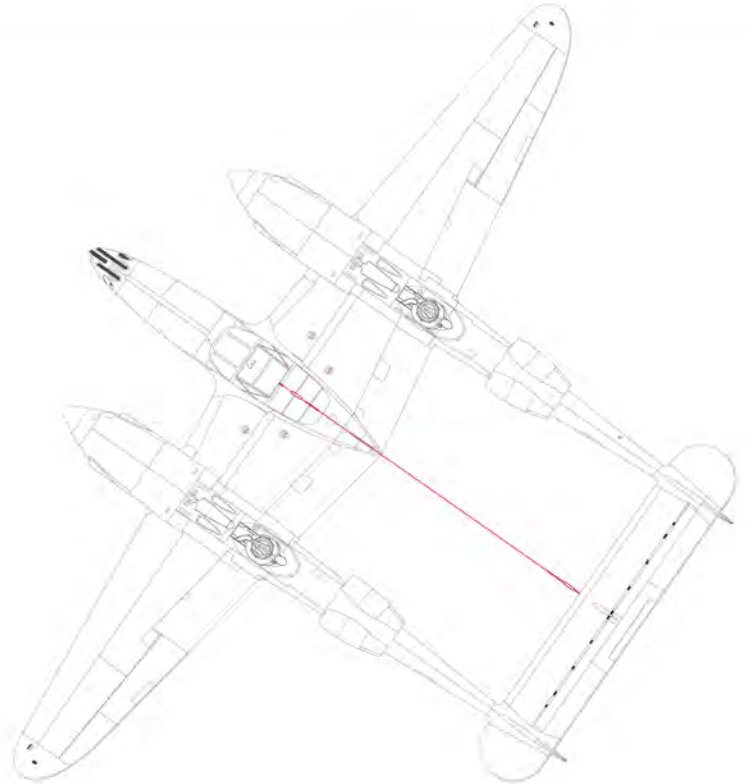

SCR-274N

The standard radio fit on P-38s was the SCR-274N. This is the setup provided by Tamiya, although they completely ignore the required "V" antenna wires leading from a mount on the forward frame of the aft cockpit glass to points on the leading edges of the vertical stabilizers.

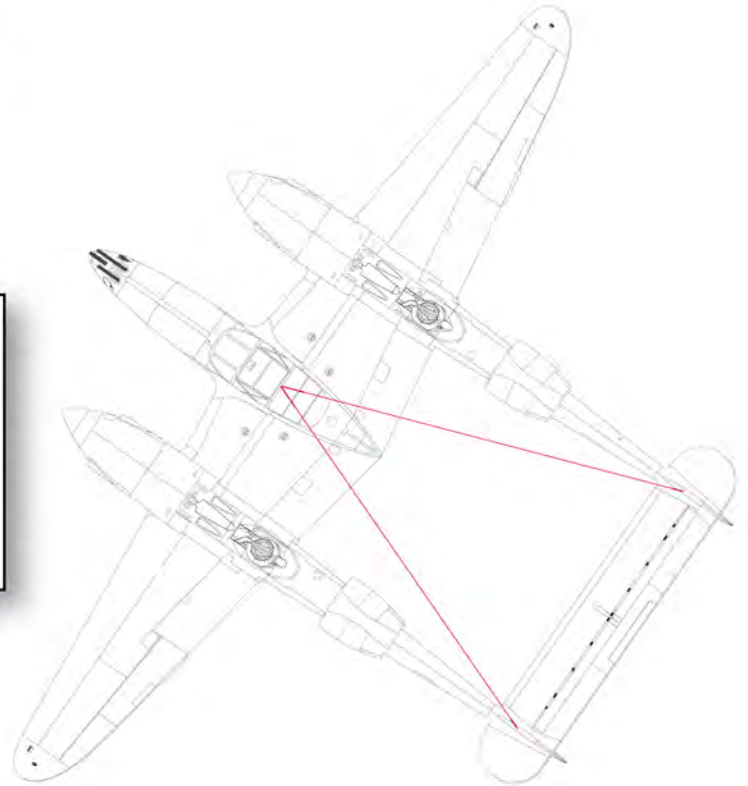

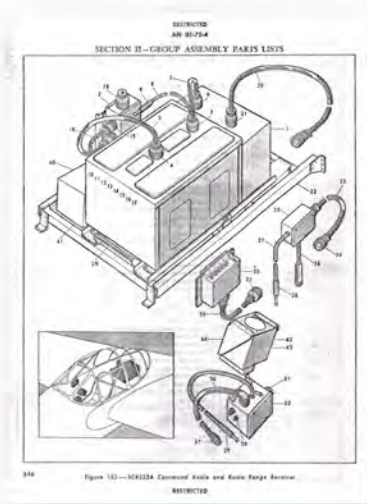

SCR-522

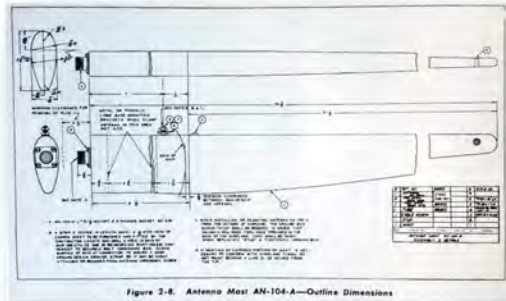
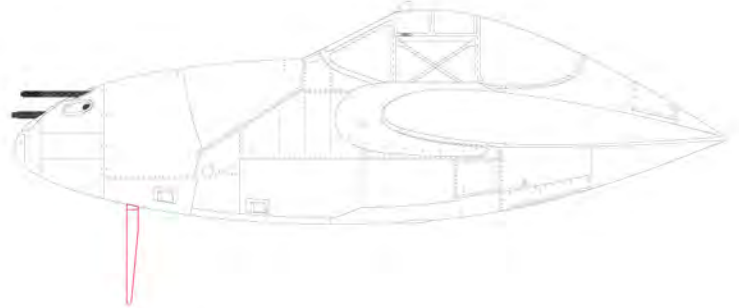

Many P-38s, particularly those in North Africa and the Mediterranean theaters, were retrofitted with the SCR-522 radio. This equipment included the prominent AN-104-A antenna mast, which was widely seen on many U.S. aircraft throughout the WWII. On the fighter Lightnings, the mast was mounted on the centerline on the lower nose. On F-4 and F-5 photo Lightnings it tended to be mounted on top of the nose so as not to interfere with the cameras. A resin SCR-522 radio set and AN-104-A mast antenna will be available from Phase Hangar Resin Accessories (www.phasehangarresin.com).

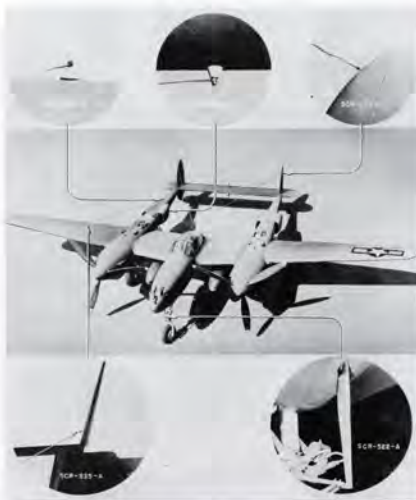

SCR-535 IFF

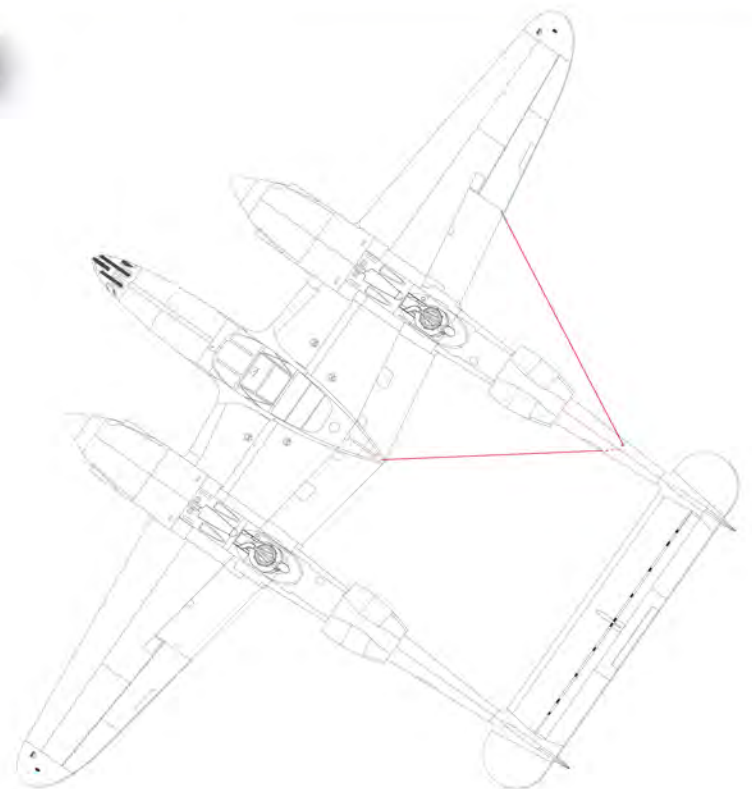

The standard IFF set installed on P-38s was the SCR-535. The antennas, if they're there at all, are virtually impossible to see in most period photos. One stretched from the upper outboard side of the right hand boom to a point just inboard from the edge of the right aileron, about 3 inches forward of the trailing edge of the wing. The second went from the bottom of the boom to a point on the upper side of the aft end of the fuselage gondola.



DECAL PLACEMENT MANUAL FOR THE

Lightning

P-38