



Mirage III C



SCALE
1:72

CAT. NO 72061

ЗБІРНА МОДЕЛЬ \ ЛІМІТОВАНИЙ ВИПУСК
PLASTIC MODEL KIT \ LIMITED EDITION



SPAN

114 mm



LENGTH

192 mm



PARTS

135 pcs

- Decal sheet
- Adhesive masks
- Photo-etched sheet

Mirage III C

ЗБІРНА МОДЕЛЬ
PLASTIC MODEL KIT
LIMITED EDITION

SCALE
1:72



ВАРІАНТИ РОЗФАРБОВАННЯ \ PAINTING VARIANTS



SCALE
1:72



MADE IN
UKRAINE



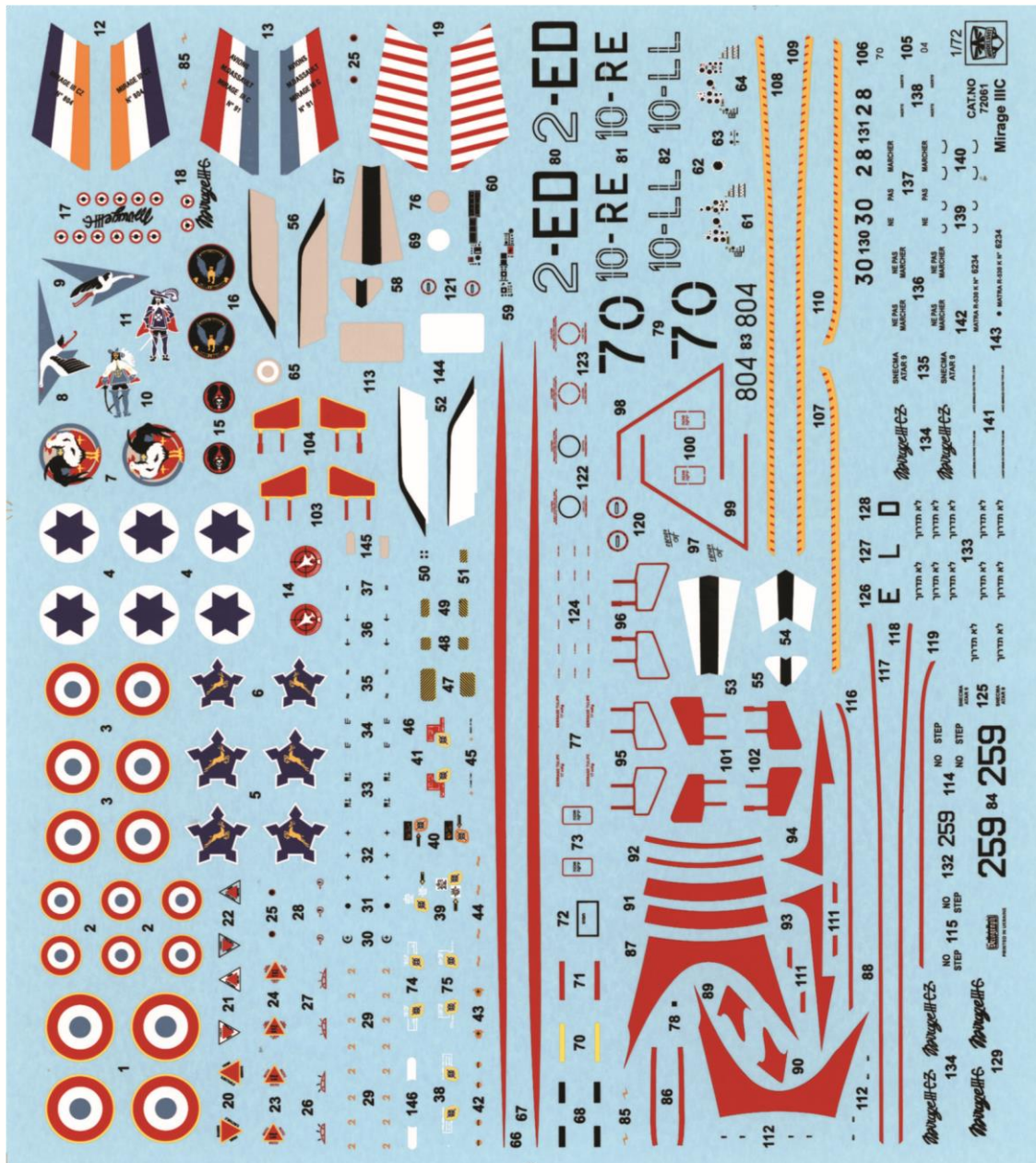

Les décalcomanies présentées respectent les proportions et sont à 100% de leur taille réelle.

Mirage IIIc



CAT.NO 72061



SCALE
1:72

SPAN: 114 mm
LENGTH: 192 mm
PARTS: 135 pieces

ЗБІРНА МОДЕЛЬ \ ЛІМІТОВАНИЙ ВИПУСК
PLASTIC MODEL KIT \ LIMITED EDITION

Dassault Mirage IIIc - французький багатопільовий винищувач другого покоління, розроблений компанією Dassault Aviation. Проектування літака проходило одночасно з сильним тиском як з боку уряду Франції, так і з жорсткою конкуренцією з світовими авіабудівельними фірмами. Незважаючи на складності з перевитратою коштів на розробку, «Міраж» модифікації IIIc вперше піднявся в повітря в жовтні 1960 року. Саме «Міраж» став першим європейським винищувачем, який вдвічі перевищив швидкість звуку.

Mirage IIIc широко поставлявся на експорт і брав участь у багатьох бойових діях. Знаковою подією в бойовій службі «Міража» є Шестиденна війна, в якій переважно завдяки «Міражам» Ізраїльським ВПС вдалося фактично знищити ВПС арабської коаліції буквально за кілька годин. Літак неодноразово модернізувався, що дозволило йому перебувати на озброєнні досить довго.



The Dassault Mirage IIIc is a second-generation multipurpose fighter aircraft developed by French aircraft company Dassault Aviation. The aircraft development was followed both by French government pressure and by severe competition of world aircraft builders. Despite the problems with overspending for aircraft development, the Mirage IIIc performed its maiden flight in October 1960. The Mirage was the first European fighter aircraft to exceed Mach 2.

The aircraft was widely exported and was used in many combat operations. The signal event of the Mirage combat service was the Six-Day War, where the Israel Air Force almost destroyed the coalition of Arab Air Forces in a few hours not least because the Mirages. The aircraft was modified oftentimes that helped it to remain in service long enough.

НЕОБХІДНІ ФАРБИ \ REQUIRED PAINTS

A Aluminium Mr.Met.Color MC218 AK Xtr.Met.- AK479	B Dark Earth Mr.Color C369 AK RC287	C Sandy Yellow Mr.Color C39 AK RC018	D Grayish Blue Mr.Color C305 AK 2144	E Dark Green Mr.Color C361 AK RC340	F Brown Leather Mr.Color C41 AK 3031	G Light Blue Grey Mr.Color C308 AK RC252	H Dark Tan Mr.Color C310 AK RC225	I Green Mr.Color C312 AK RC232	J Sand Mr.Color C313 AK RC226	K Light Blue Mr.Color C314 AK RC241
L Gun Metal Mr.Met.Color MC214 AK Xtr.Met.- AK483	M Red Mr.Color C47 AK RC503	N White Mr.Color C62 AK RC004	O Flat Black Mr.Color C33 AK RC001	P Pale Sand Mr.Color C318 AK RC018	Q Blue Mr.Color C110 AK RC011	R Zinc Chromate Mr.Color C351 AK RC028	S Light Gull Grey Mr.Color C315 AK RC220	T Yellow Mr.Color C4 AK RC007	U Khaki Mr.Color C55 AK RC096	V Rubber/Tires Mr.Color C137 AK RC022
W Burnt Metal Mr.Color C61 AK Xtr.Met.- AK484	X Chrom Silver Mr.Met.Color MC211 AK Xtr.Met.- AK477	Y White Grey Mr.Color C107 AK RC003	Z Steel Mr.Met.Color MC213 AK Xtr.Met.- AK476							

УМОВНІ СИМВОЛИ \ USED SYMBOLS

1 ЕТАПИ ЗБИРАННЯ STAGES OF ASSEMBLY	A1 НОМЕР ДЕТАЛІ PART NUMBER	1 ОКРЕМІ ДЕТАЛІ SEPARATE DETAILS	1 НАКЛЄЙТИ ДЕКАЛИ APPLY DECALS	1 НАКЛЄЙТИ МАСКУ APPLY THE ADHESIVE MASK	? НА ВИБІР OPTIONAL
A ВАРІАНТИ ДЛЯ ЗБИРАННЯ VARIANTS OF ASSEMBLY	S КЛЄЙТИ НА СУПЕРКЛЕЙ GLUE ON "SUPER GLUE"	X НЕ КЛЄЙТИ DON'T GLUE	✂ ЗРОБИТИ ОТВІР MAKE A HOLE	✂ ВІДРІЗАТИ НОЖЕМ DETACH WITH KNIFE	A ФАРБУВАТИ TO PAINT

Модель вироблена за технологією «short run»
і призначена для досвідчених моделістів

This model is produced using short run technology,
designed for experienced modelers



КОМПЛЕКТНІСТЬ / COMPLETE SET

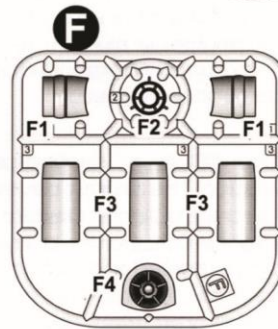
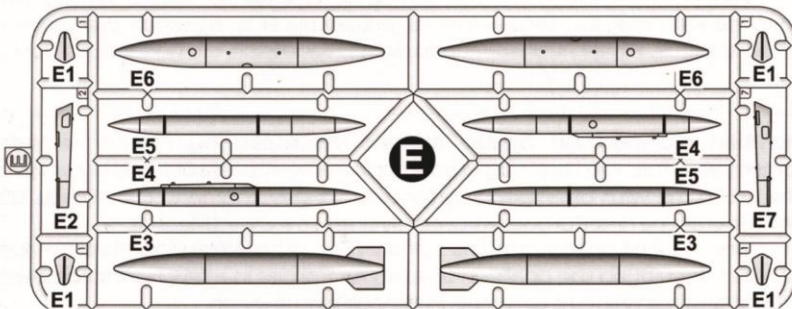
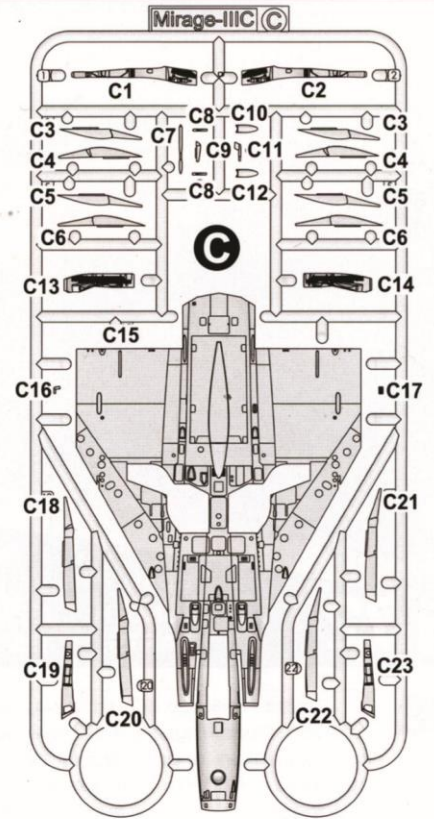
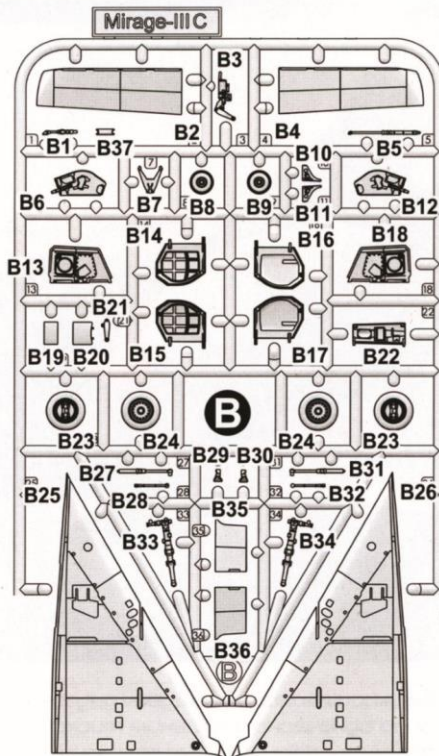
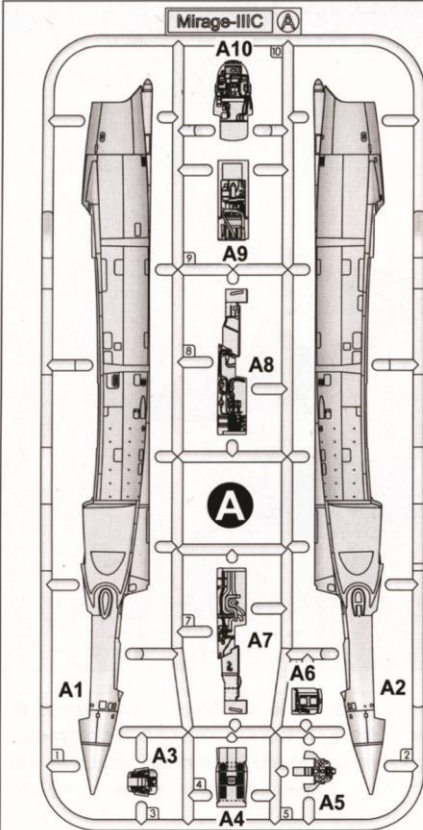

маски для фарбування
masks for painting

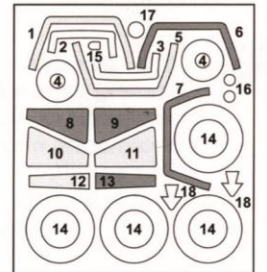

зовні outside
всередині inside

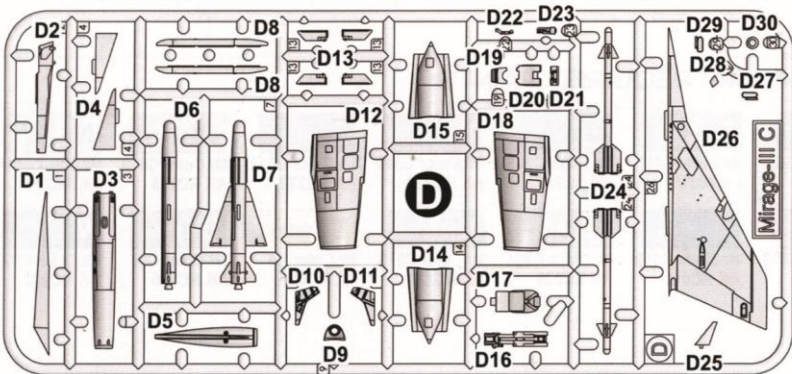

одна декаль для шести варіантів забарвлення
one decal for six versions of colouring

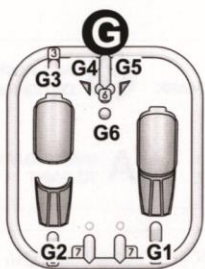
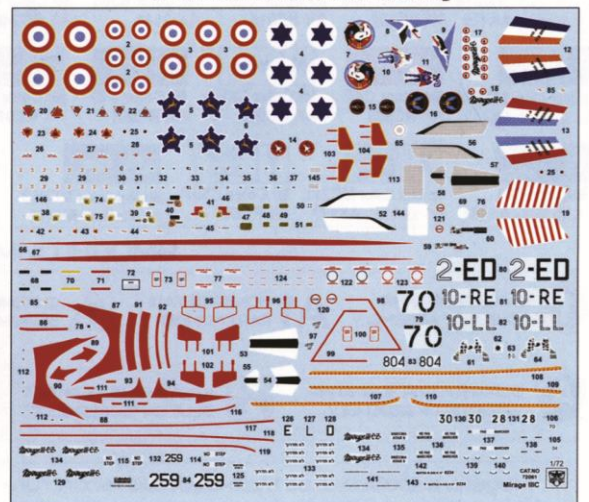

плівка з прозорими
детальми
film with transparent
details





СХЕМА ЗБИРАННЯ / THE SCHEME OF ASSEMBLY



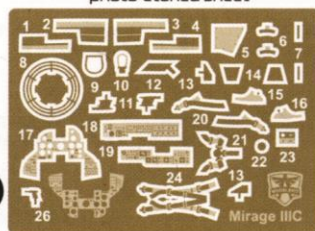

СХЕМА ЗБИРАННЯ / THE SCHEME OF ASSEMBLY



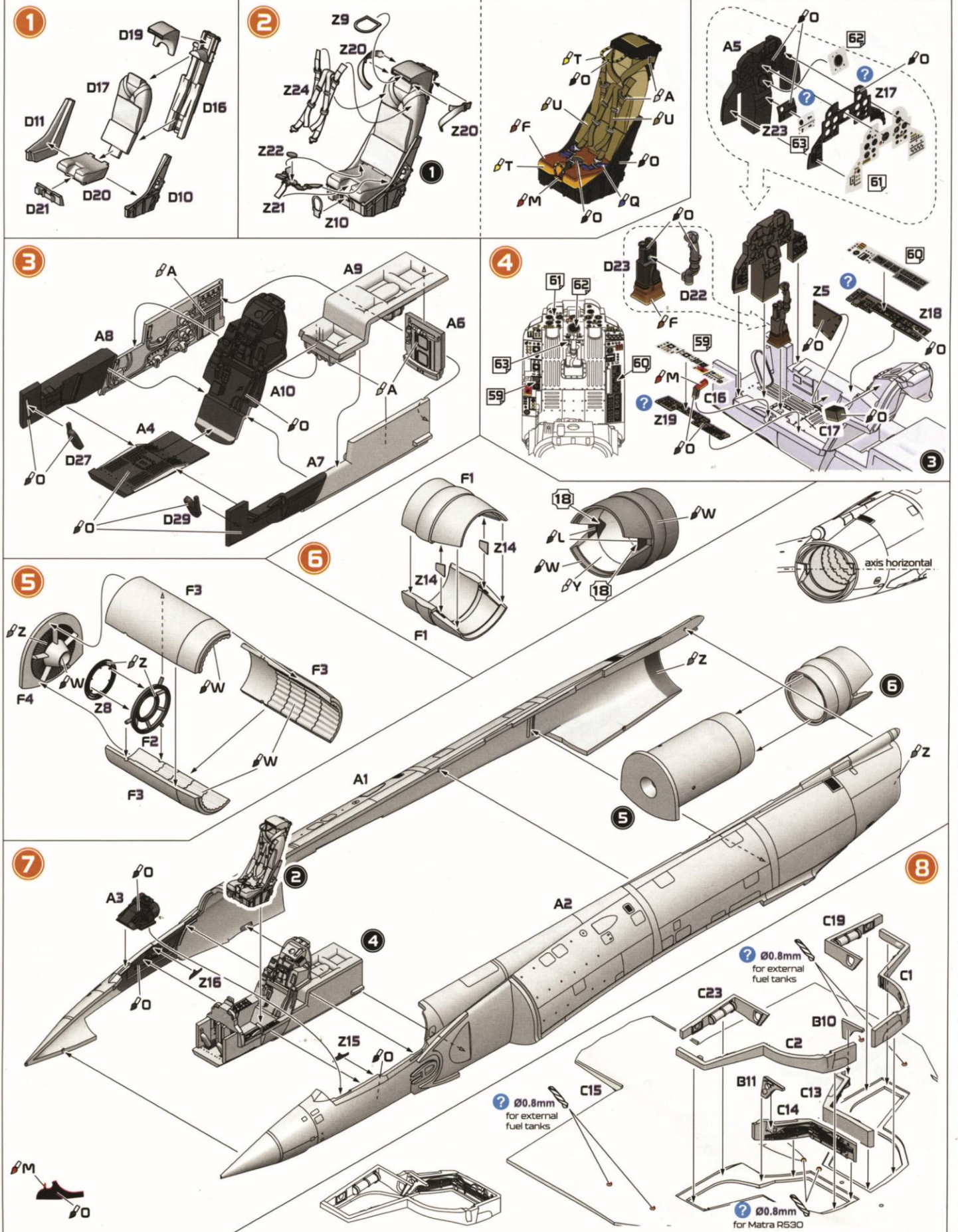

СХЕМА ЗБИРАННЯ / THE SCHEME OF ASSEMBLY



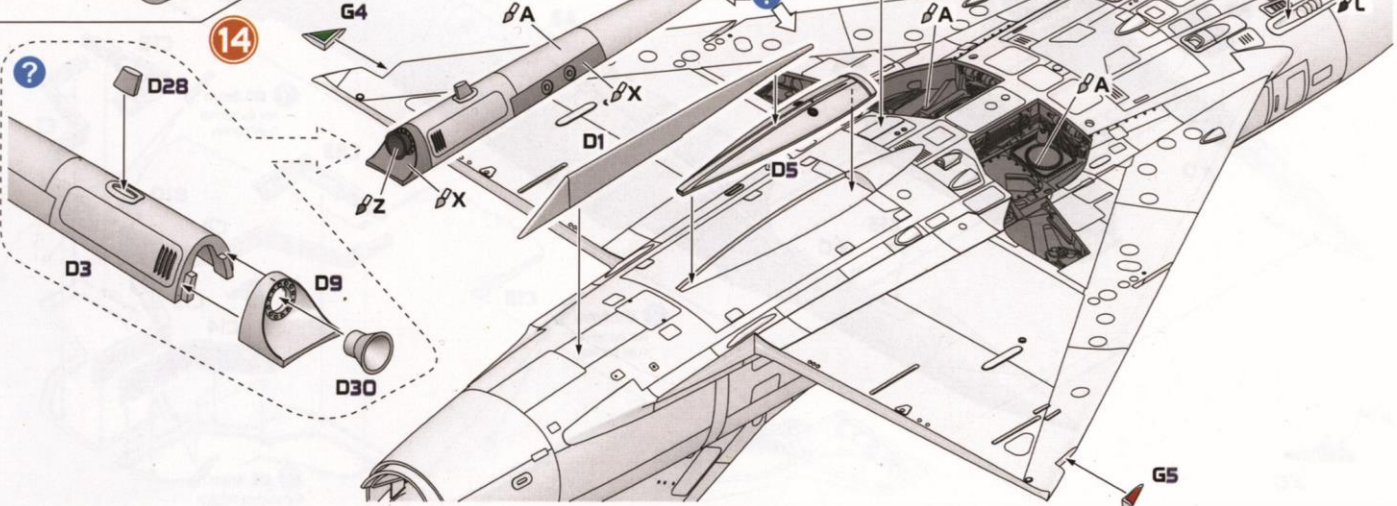
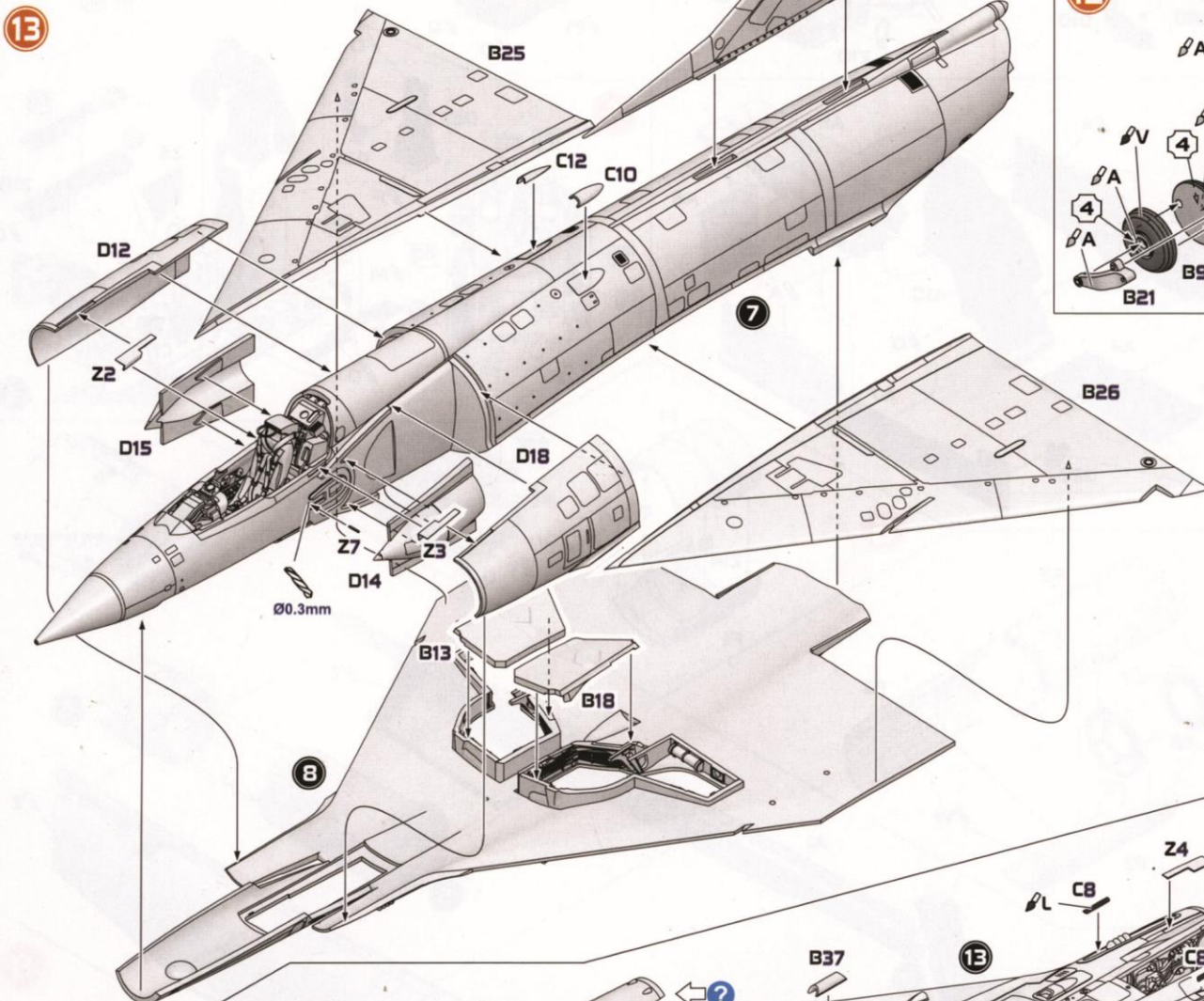
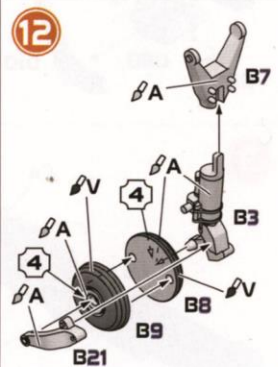
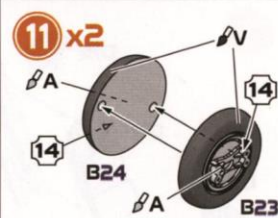
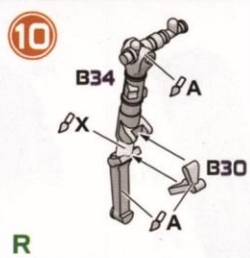
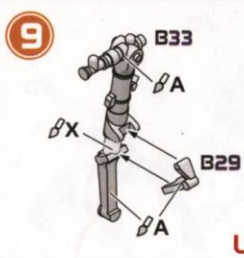

СХЕМА ЗБИРАННЯ / THE SCHEME OF ASSEMBLY

18

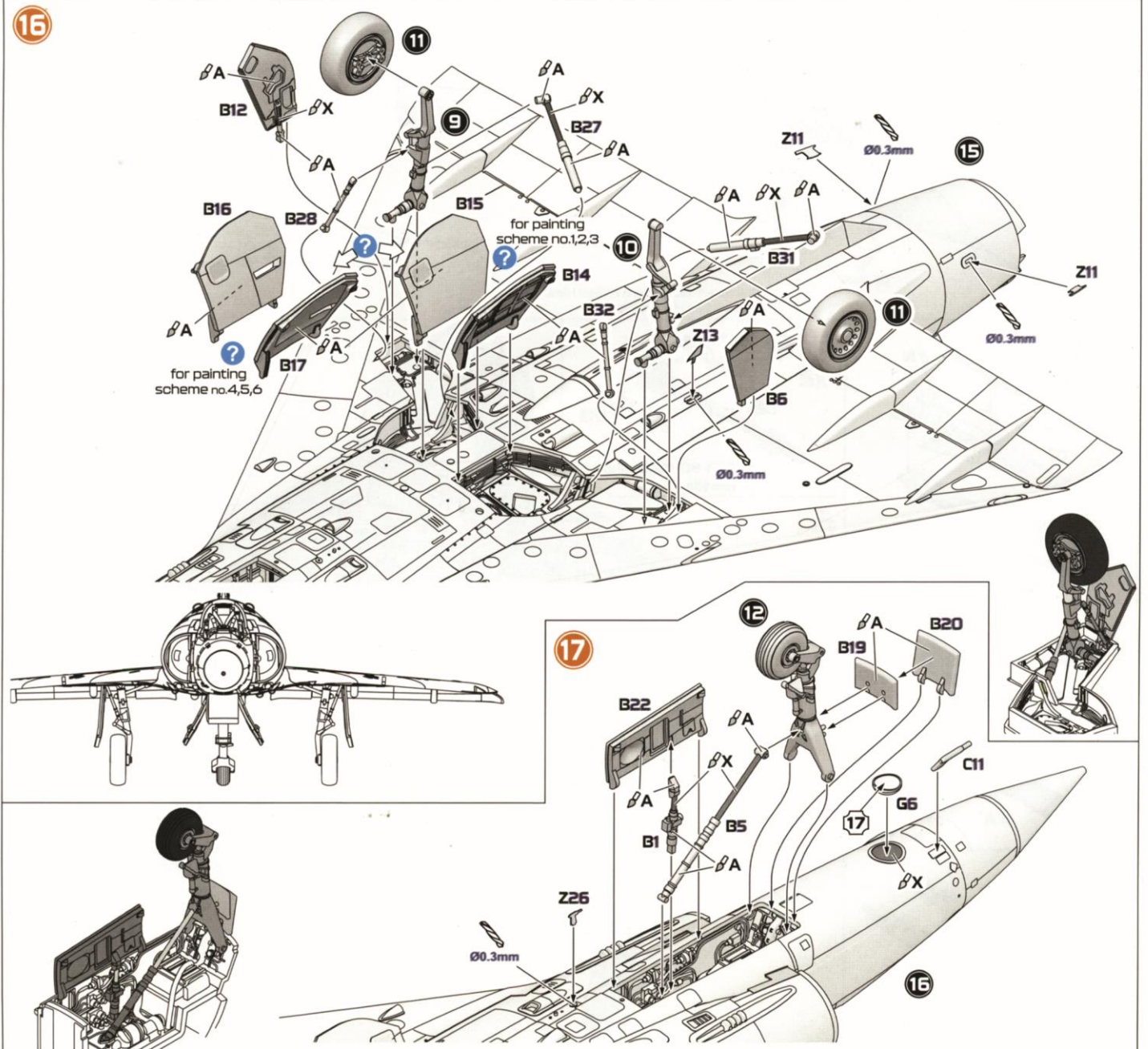
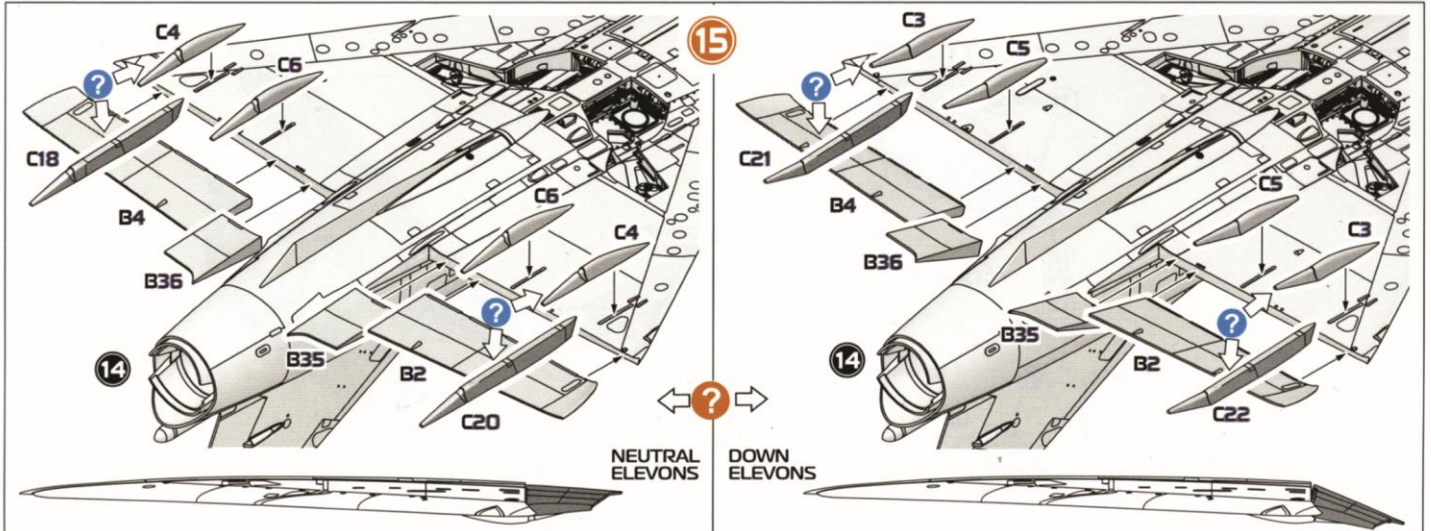
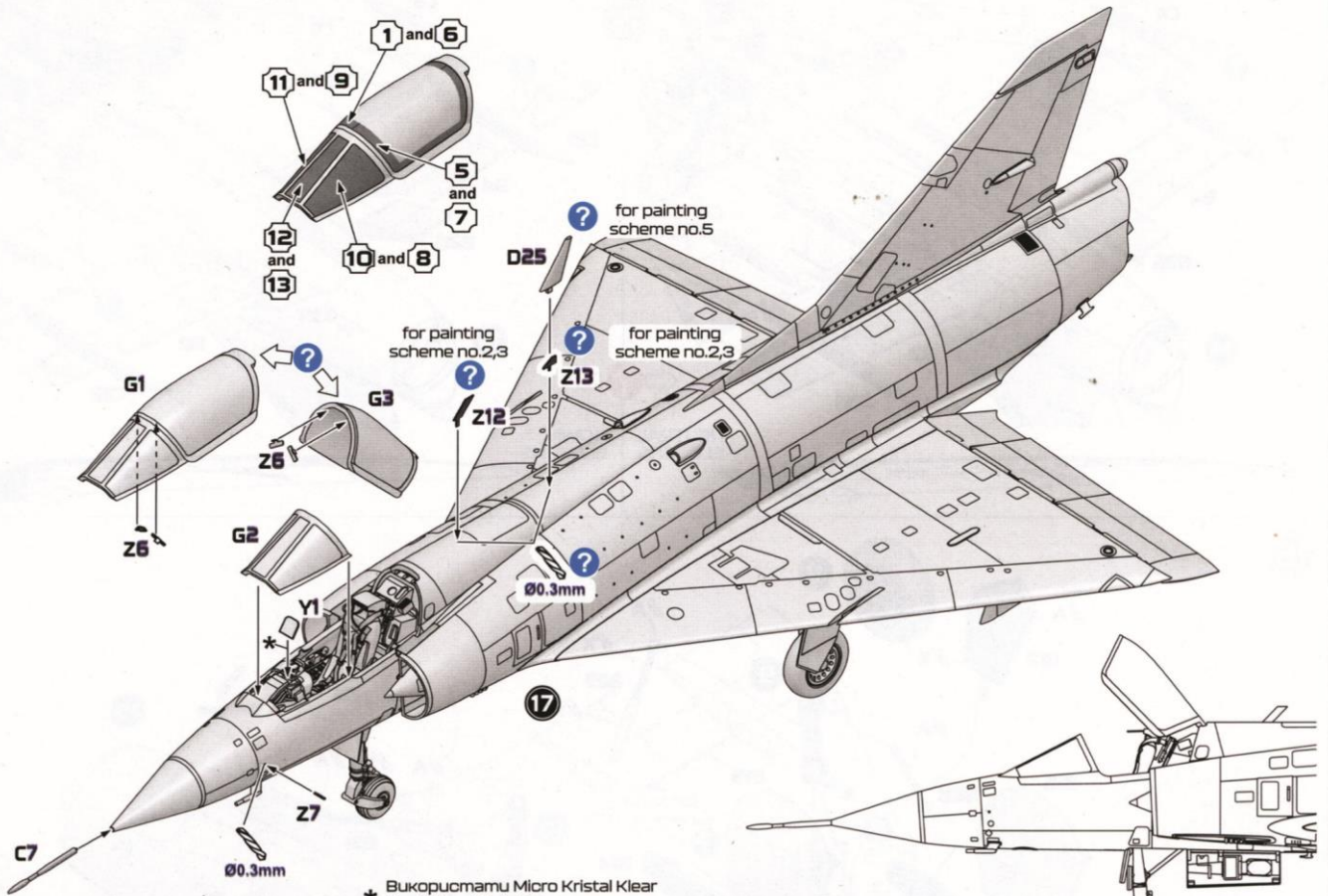

* Використовуйте Micro Kristal Klear
Use Micro Kristal Klear

19 ?

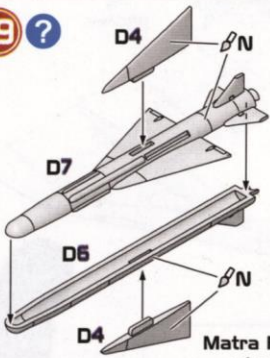

Matra R530 missile

22 ?
x2

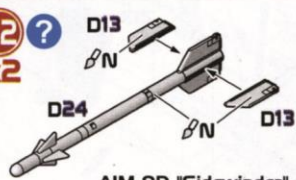

AIM-9D "Sidewinder" missile

20 ?
x2

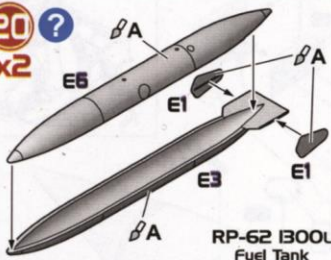

RP-62 1300L Fuel Tank

21 ?
x2

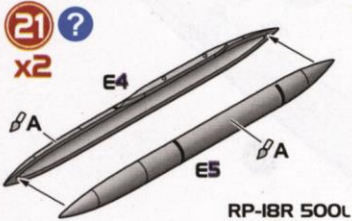

RP-1BR 500L Fuel Tank

23





СХЕМА РОЗФАРБУВАННЯ / PAINTING SCHEME

1 Mirage IIIC 2-ED n° 91, E.C. 1/2 "Cigognes", авіабаза Діжон-Лонгвіч, Франція, 1967 рік
 Mirage IIIC 2-ED n° 91, E.C. 1/2 "Cigognes", Dijon-Longvic Air Base, France, 1967

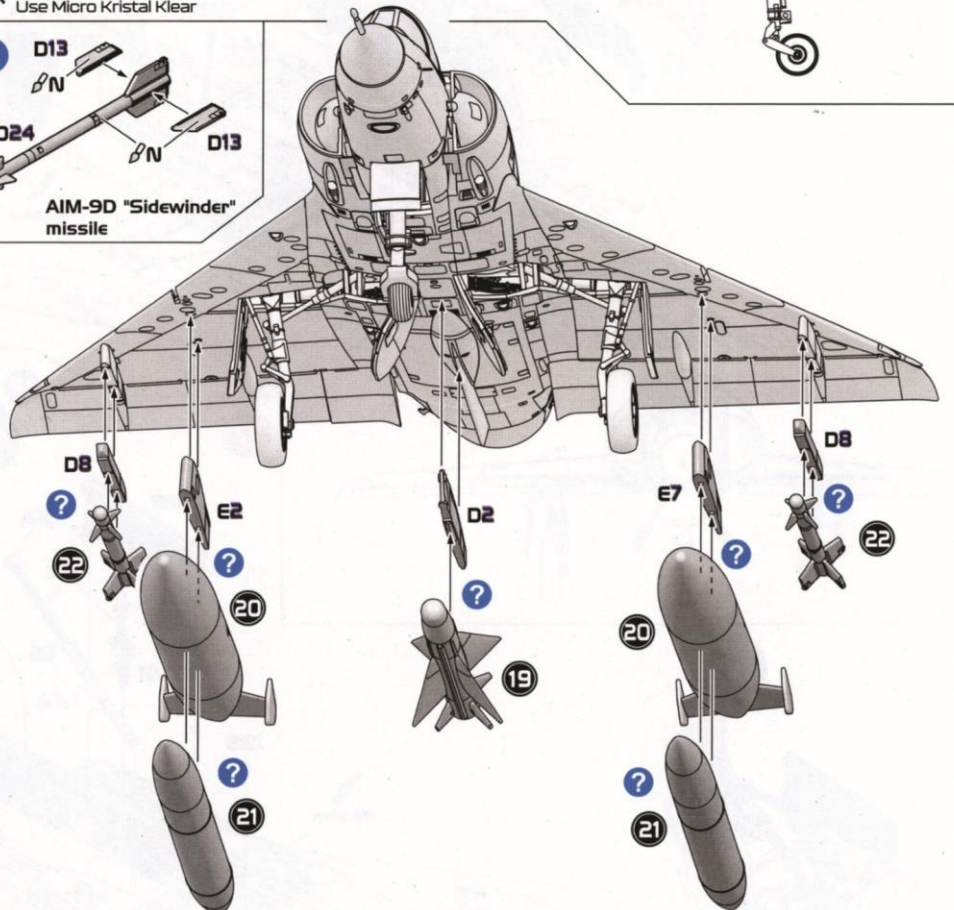
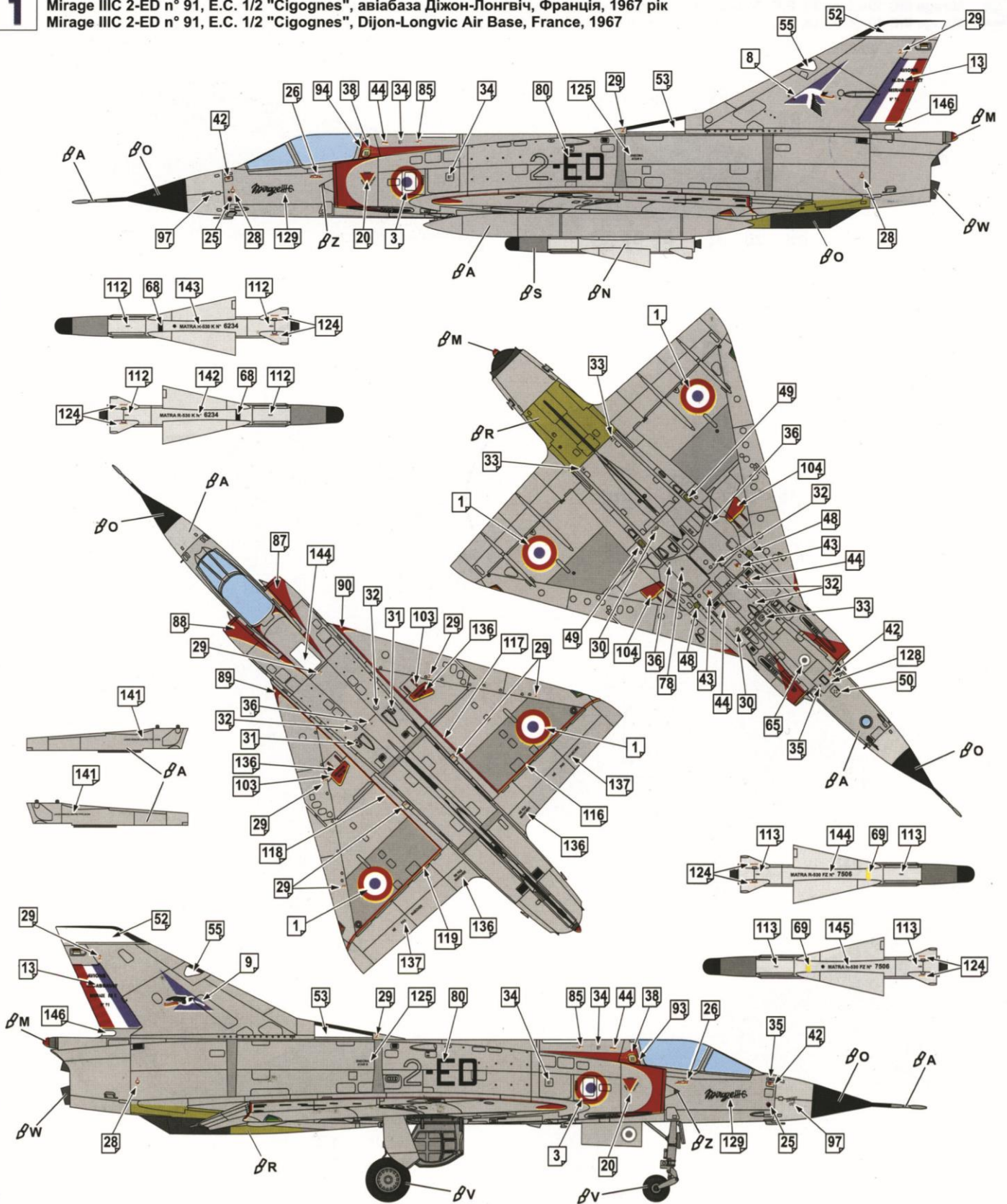

A Aluminium Mr.Met.Color MC218 AK Xtr.Met.- AK479	L Gun Metal Mr.Met.Color MC214 AK Xtr.Met.- AK483	M Red Mr.Color C47 AK RC503	N White Mr.Color C62 AK RC004	O Flat Black Mr.Color C33 AK RC001	R Zinc Chromate Mr.Color C351 AK RC028	W Burnt Metal Mr.Color C61 AK Xtr.Met.- AK484	S Light Gull Grey Mr.Color C315 AK RC220	V Rubber/Tires Mr.Color C137 AK RC022	Z Steel Mr.Met.Color MC213 AK Xtr.Met.- AK476
--	--	--	--	---	---	--	---	--	--



СХЕМА РОЗФАРБУВАННЯ / PAINTING SCHEME

2 Mirage IIIC 10-LL n° 28, E.C. 3/10 Vexin, Повітряний загін 188, Джибуті, жовтень 1984 року
Mirage IIIC 10-LL n° 28, E.C. 3/10 Vexin, Detachment Air 188, Djibouti, October 1984

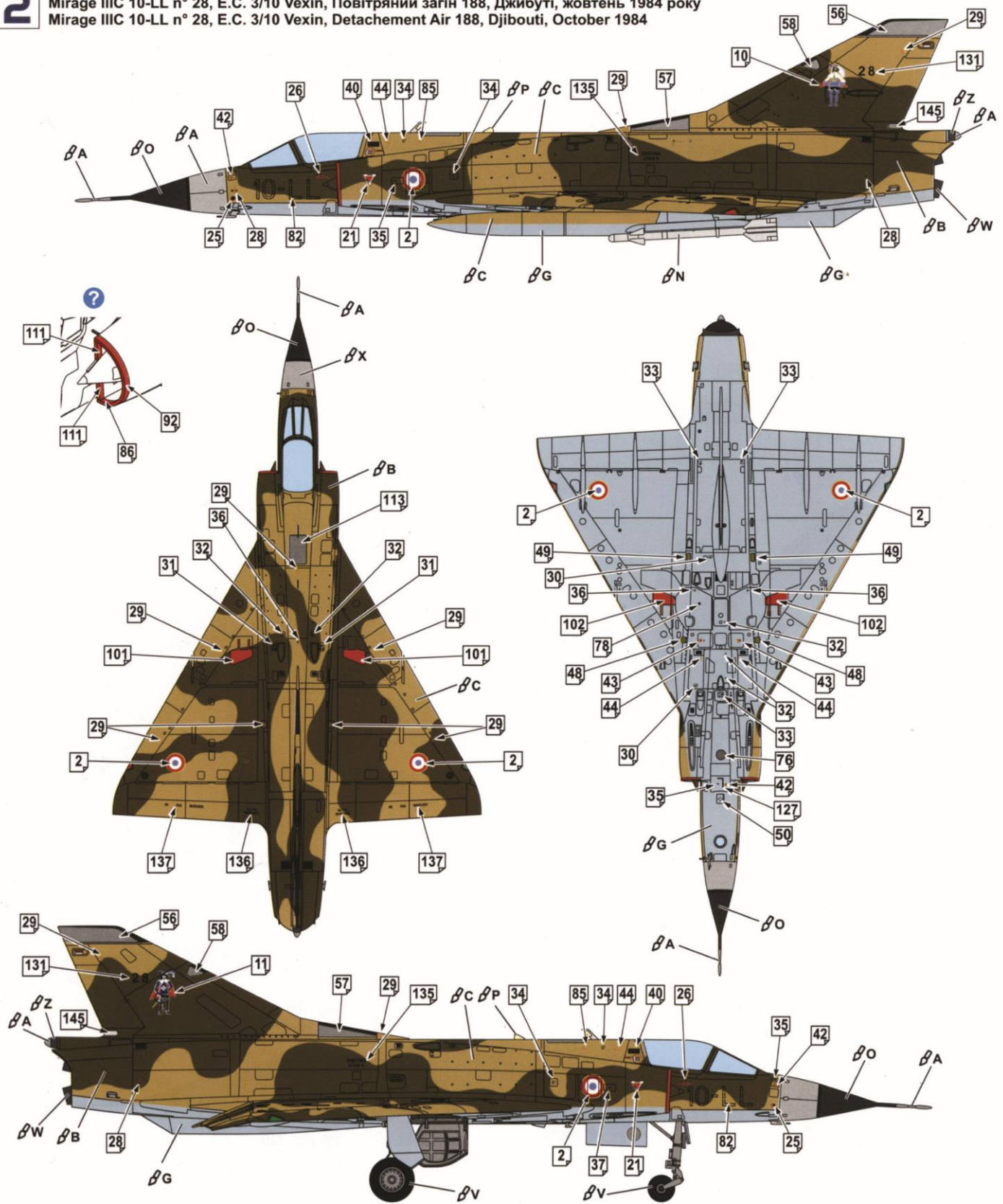

A Aluminium Mr.Met.Color MC218 AK Xtr.Met. - AK479	B Dark Earth Mr.Color C369 AK RC287	C Sandy Yellow Mr.Color C39 AK RC018	G Light Blue Grey Mr.Color C308 AK RC252	W Burnt Metal Mr.Color C61 AK Xtr.Met. - AK484	N White Mr.Color C62 AK RC004	O Flat Black Mr.Color C33 AK RC001	P Pale Sand Mr.Color C318 AK RC018	V Rubber/Tires Mr.Color C137 AK RC022	Z Steel Mr.Met.Color MC213 AK Xtr.Met. - AK476
---	--	---	---	---	--	---	---	--	---



СХЕМА РОЗФАРБУВАННЯ / PAINTING SCHEME

3 Mirage IIIC 10-RE n° 30, E.C. 2/10 "Seine", авіабаза Крей, Франція, травень 1978 року
Mirage IIIC 10-RE n° 30, E.C. 2/10 "Seine", Creil Air Base, France, May 1978

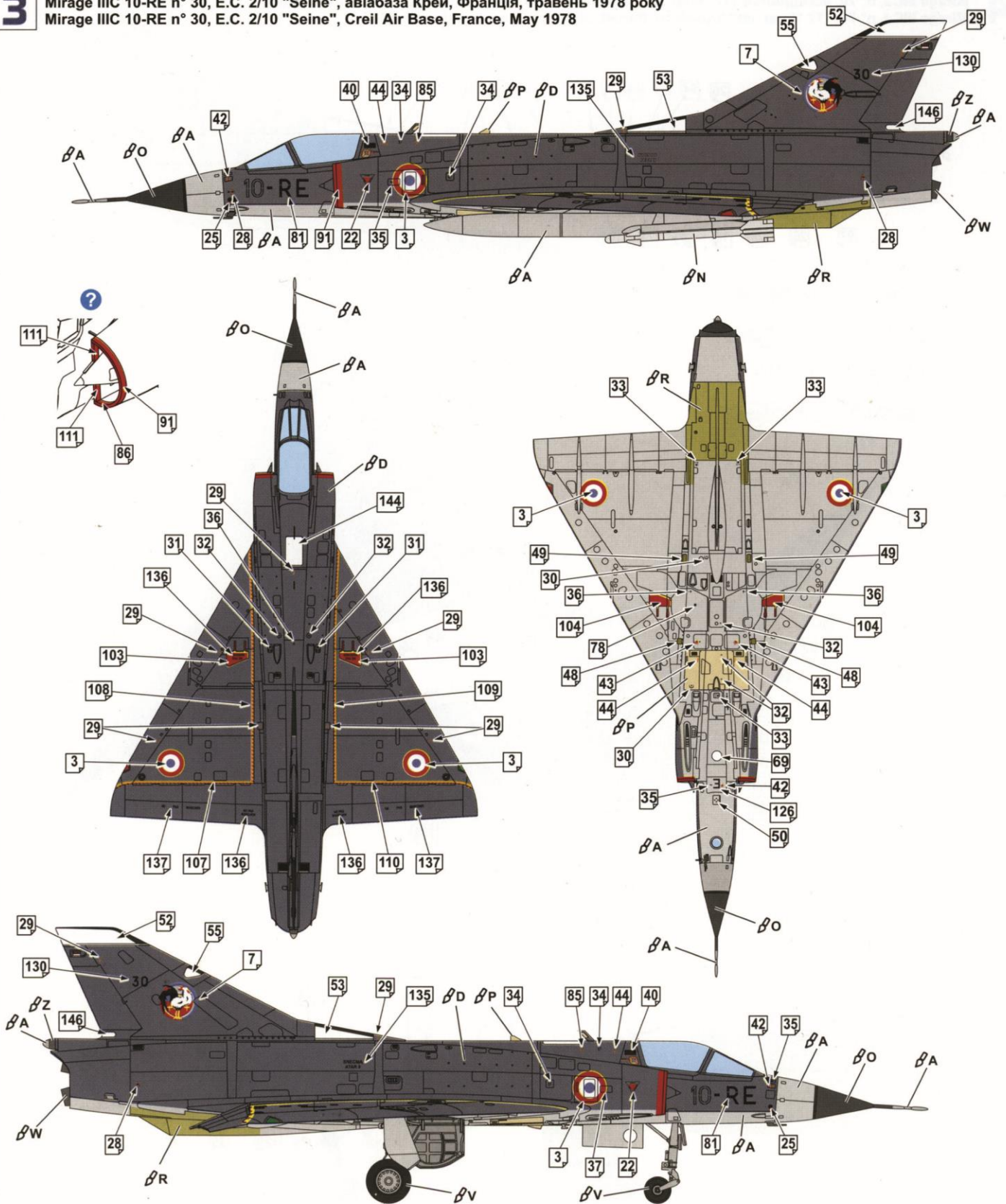

A Aluminium

Mr.Met.Color MC218
AK Xtr.Met.- AK479

D Grayish Blue

Mr.Color C305
AK 2144

N White

Mr.Color C62
AK RC004

W Burnt Metal

Mr.Color C61
AK Xtr.Met.- AK484

O Flat Black

Mr.Color C33
AK RC001

P Pale Sand

Mr.Color C318
AK RC018

R Zinc Chromate

Mr.Color C351
AK RC028

V Rubber/Tires

Mr.Color C137
AK RC022



СХЕМА РОЗФАРБУВАННЯ / PAINTING SCHEME

4 Mirage IIICJ, n° 70, ескадрилья 117 "First Jet", авіабаза Рамат Девід, Ізраїль, червень 1967 року
Mirage IIICJ, n° 70, 117 "First Jet" Squadron, Ramat David Air Base, Israel, June 1967

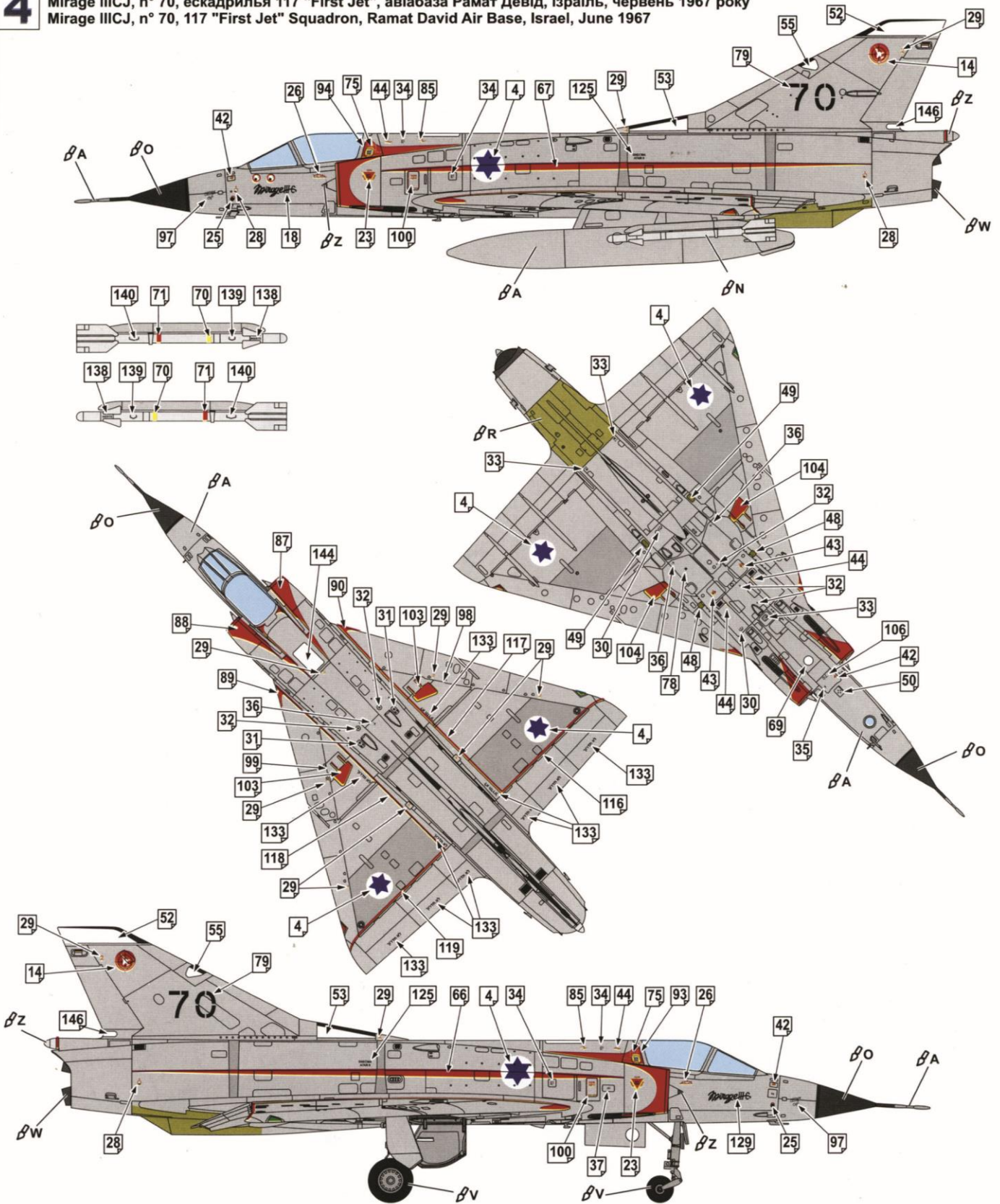

A Aluminium

Mr.Met.Color MC218
AK Xtr.Met.- AK479

M Red

Mr.Color C47
AK RC503

N White

Mr.Color C62
AK RC004

O Flat Black

Mr.Color C33
AK RC001

R Zinc Chromate

Mr.Color C351
AK RC028

W Burnt Metal

Mr.Color C61
AK Xtr.Met.- AK484

V Rubber/Tires

Mr.Color C137
AK RC022

Z Steel

Mr.Met.Color MC213
AK Xtr.Met.- AK476



СХЕМА РОЗФАРБУВАННЯ / PAINTING SCHEME

5 Mirage IIICJ, n° 259 (колишній 59), ескадрилья 101, авіабаза Хатзор, Ізраїль, 1971 рік
Mirage IIICJ, n° 259 (former 59), Tayeset 101, Hatzor Air Base, Israel, 1971

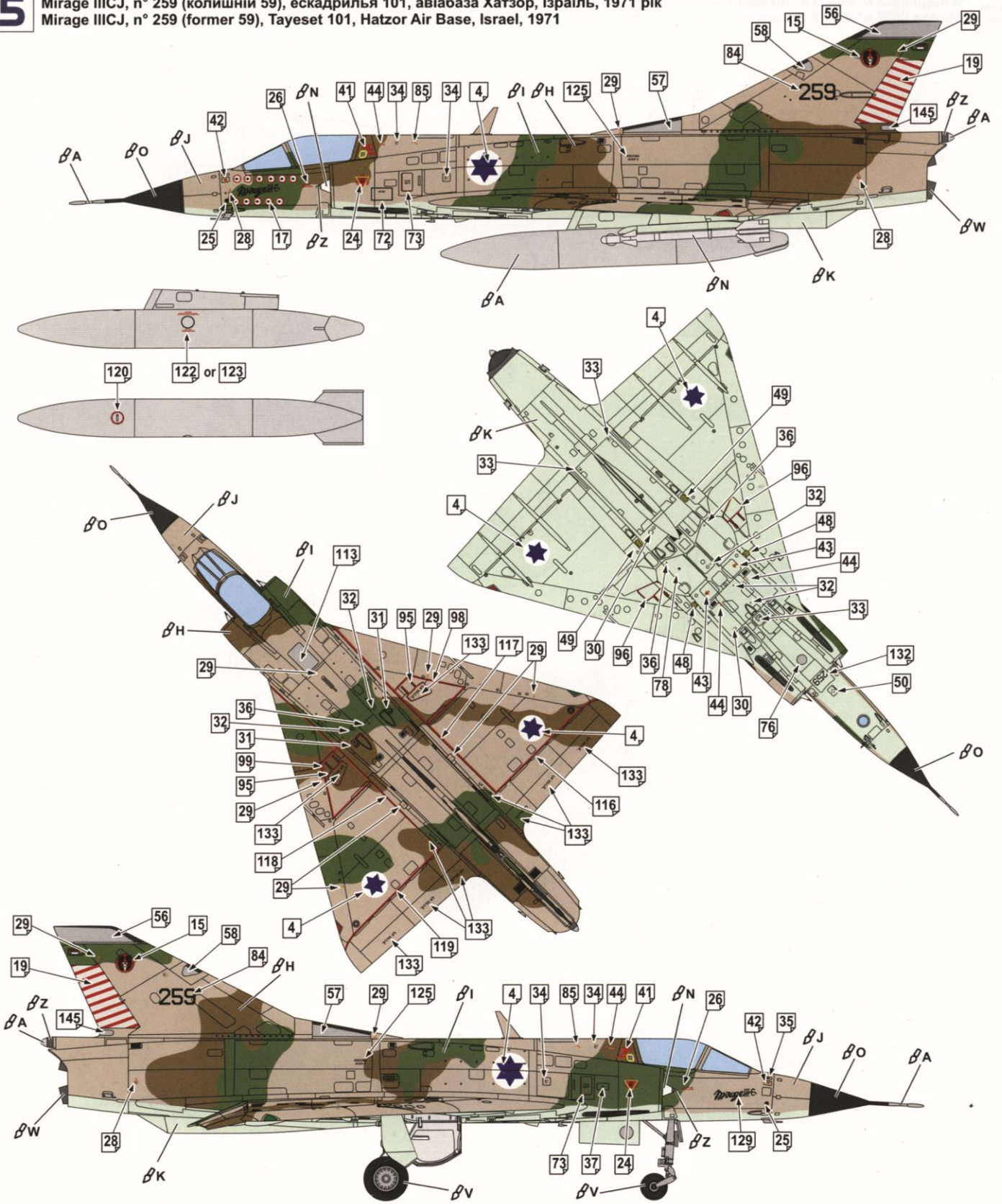

A Aluminium Mr.Met.Color MC218 AK Xtr.Met.- AK479	H Dark Tan Mr.Color C310 AK RC225	I Green Mr.Color C312 AK RC232	J Sand Mr.Color C313 AK RC226	K Light Blue Mr.Color C314 AK RC241	N White Mr.Color C62 AK RC004	O Flat Black Mr.Color C33 AK RC001	W Burnt Metal Mr.Color C61 AK Xtr.Met.- AK484	V Rubber/Tires Mr.Color C137 AK RC022	Z Steel Mr.Met.Color MC213 AK Xtr.Met.- AK476
--	--	---	--	--	--	---	--	--	--



СХЕМА РОЗФАРБУВАННЯ / PAINTING SCHEME

6 Mirage IIICZ n° 804, 2-я ескадрилья «Літаючі гепарди», авіабаза Waterkloof, ПАР, 1982 рік
Mirage IIICZ n° 804, 2 Squadron "Flying Cheetahs", Waterkloof Air Base, Republic of South Africa, 1982

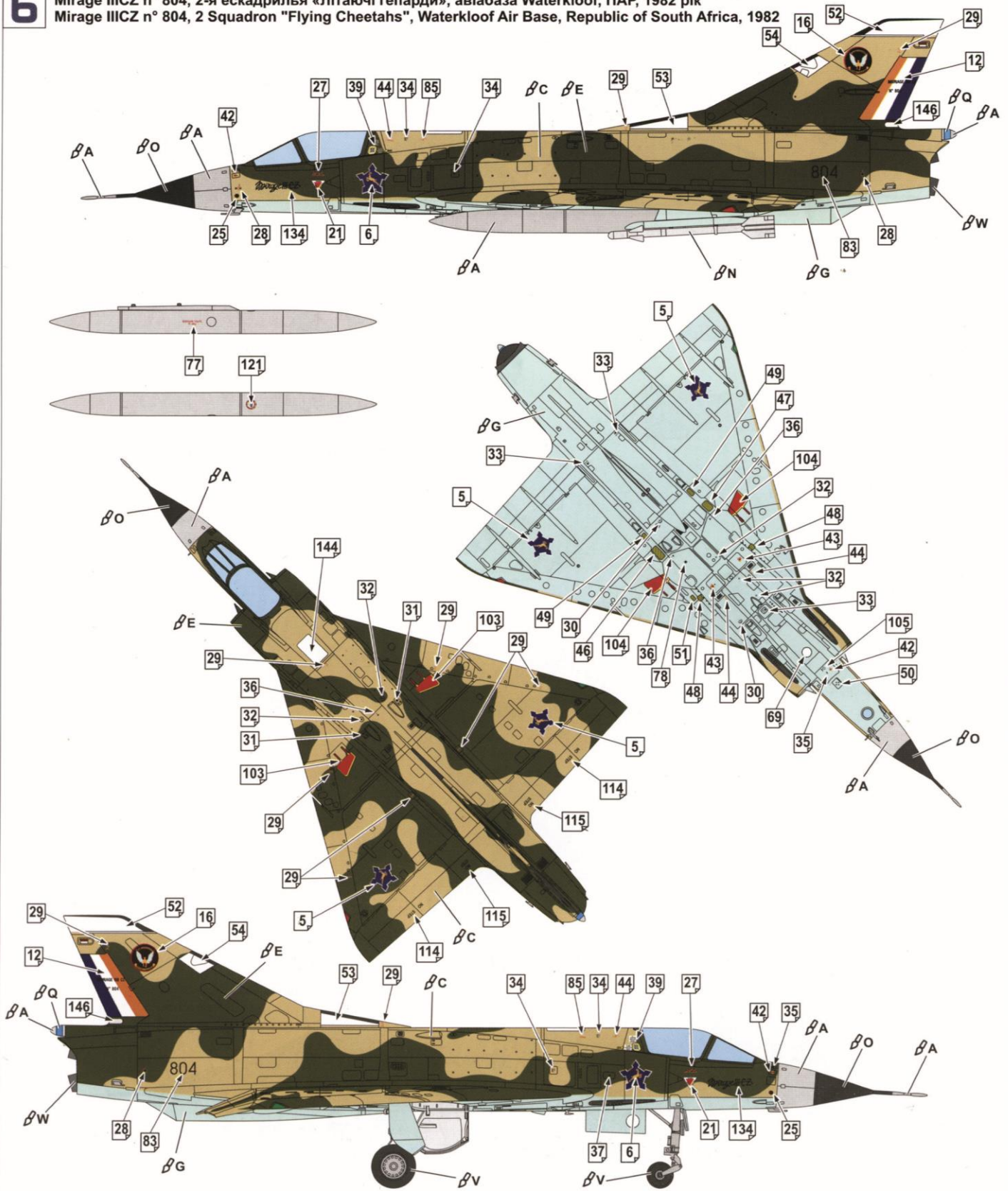

A Aluminium

Mr.Met.Color MC218
AK Xtr.Met.- AK479

E Dark Green

Mr.Color C361
AK RC340

C Sandy Yellow

Mr.Color C39
AK RC018

G Light Blue

Mr.Color C117
AK RC321

N White

Mr.Color C62
AK RC004

O Flat Black

Mr.Color C33
AK RC001

Q Blue

Mr.Color C110
AK RC011

W Burnt Metal

Mr.Color C61
AK Xtr.Met.- AK484

V Rubber/Tires

Mr.Color C137
AK RC022