

# DHC-2

## BEAVER



**SIX MARKING OPTIONS  
DESIGNED FOR THE HOBBYCRAFT KIT  
1/48 SCALE**

DECALS PRINTED BY



**OPTION 1: L-20A BEAVER 51-16532**

50TH TFW, USAF

HAHN AB, 1958

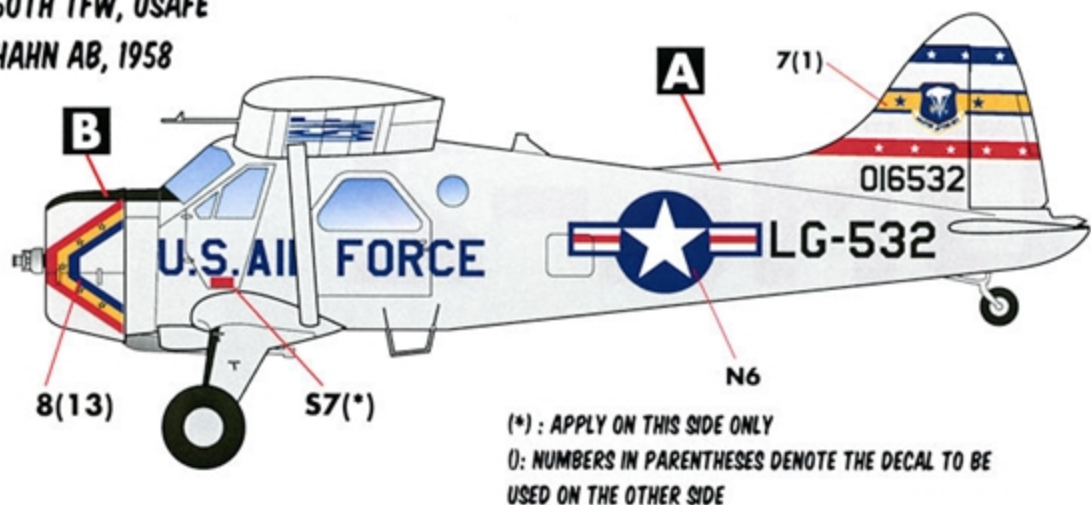

(\*) : APPLY ON THIS SIDE ONLY  
(): NUMBERS IN PARENTHESES DENOTE THE DECAL TO BE USED ON THE OTHER SIDE

**OPTION 4: U-6A 53-2781**

6512 TEST SQ., USAF FLIGHT TEST CENTER

EDWARDS AFB, 1993

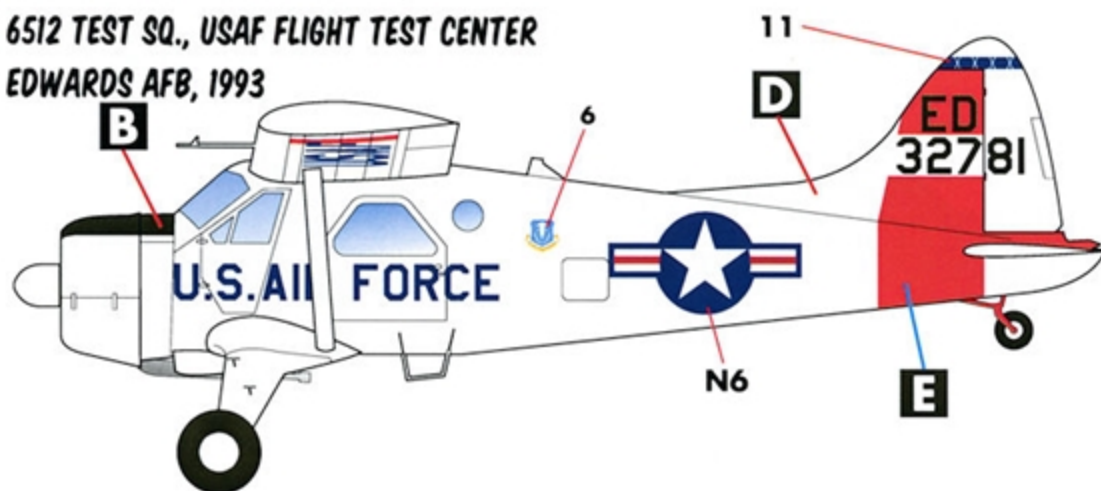

**OPTION 2: L-20A BEAVER 52-6138**

81ST FBW, USAF

RAF BENTWATERS, 1960

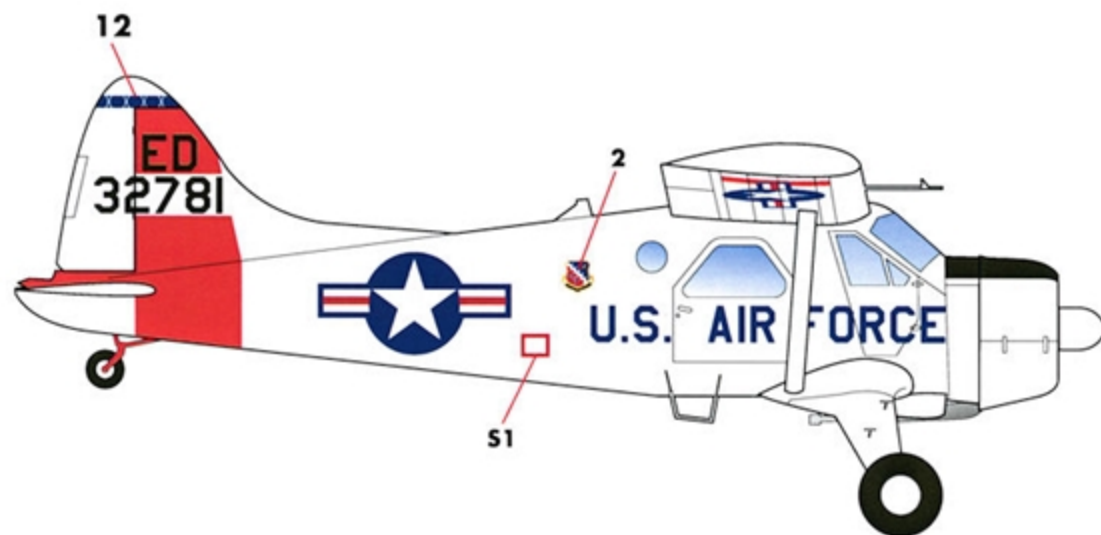
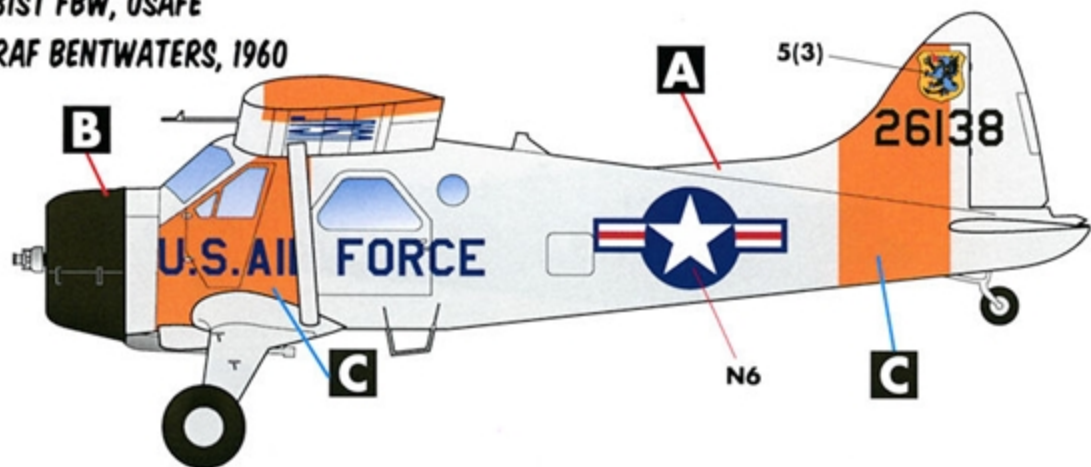

**OPTION 3: U-6A 53-2833**

US ARMY, JAPAN

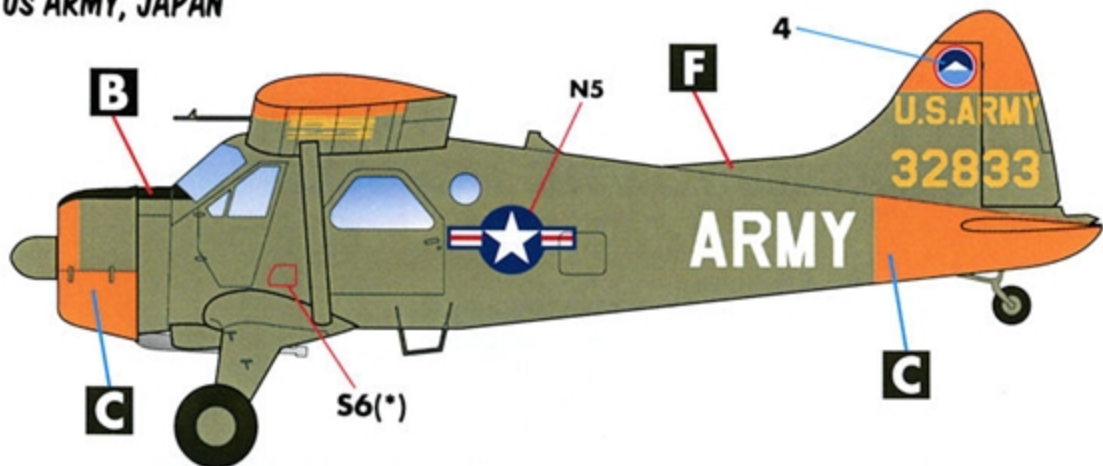

**OPTION 5: U-6A BUNO. 150191**

US NAVAL TEST PILOT SCHOOL, US NAVY

1970S

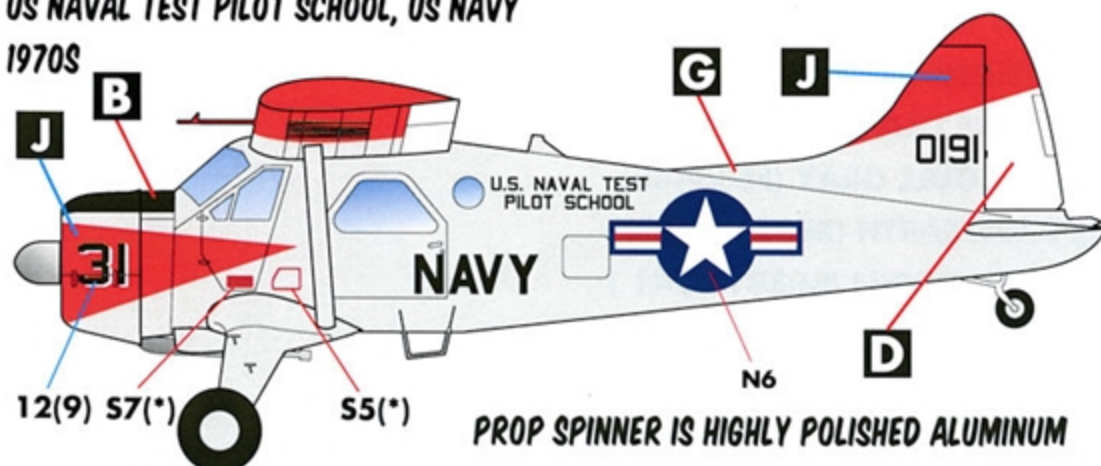

PROP SPINNER IS HIGHLY POLISHED ALUMINUM



### OPTION 1

D1 = 1.5 in (38.1 mm)  
D2 = 0.895 in (22.7 mm)

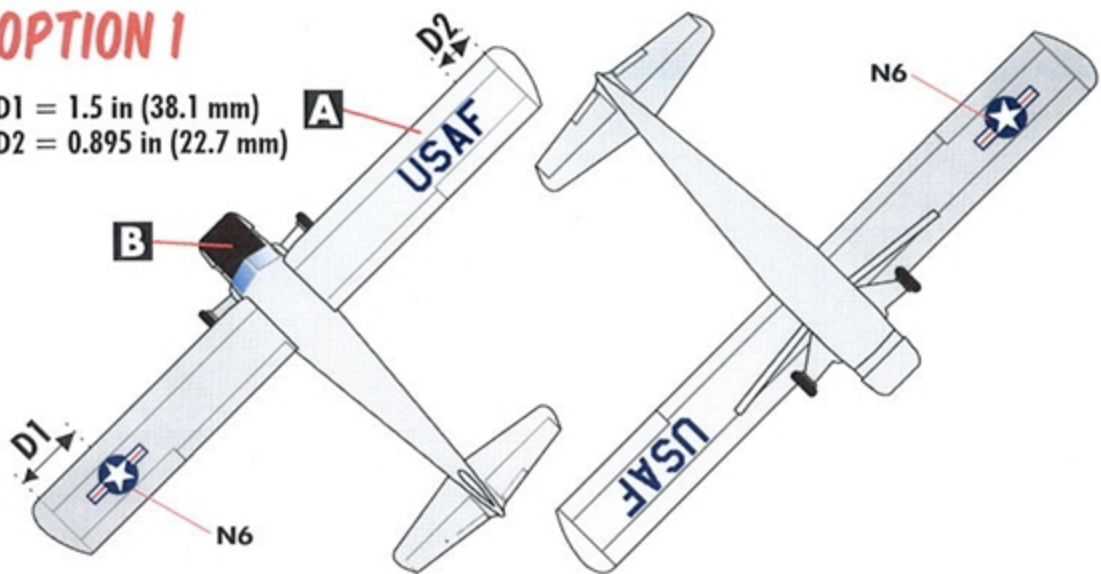

### OPTION 4

D6 = 1 in (25.4 mm)

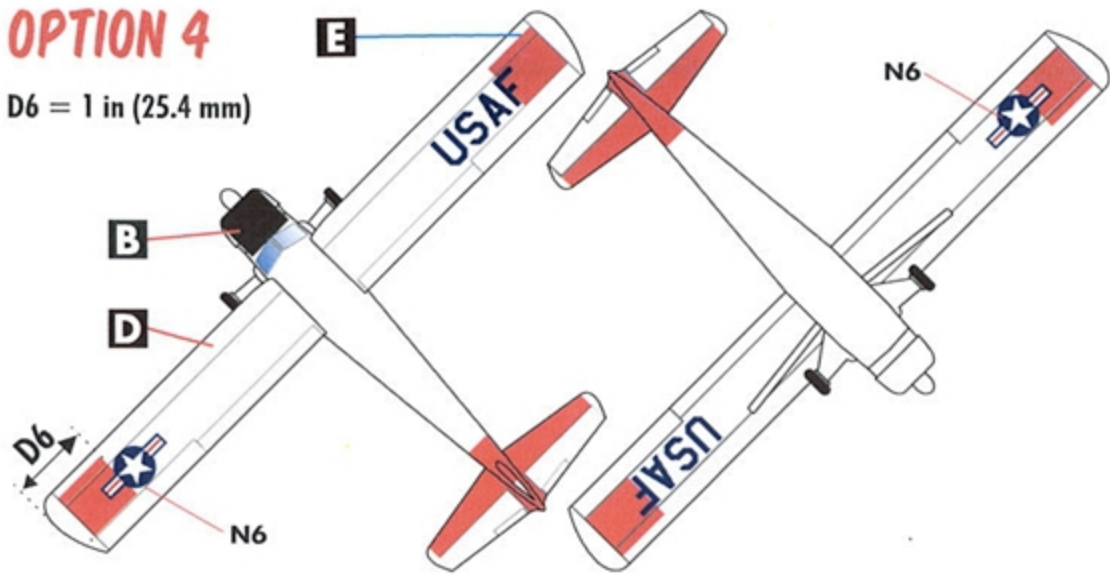

### OPTION 2

D3 = 1 in (25.4 mm)  
D4 = 0.75 in (19 mm)

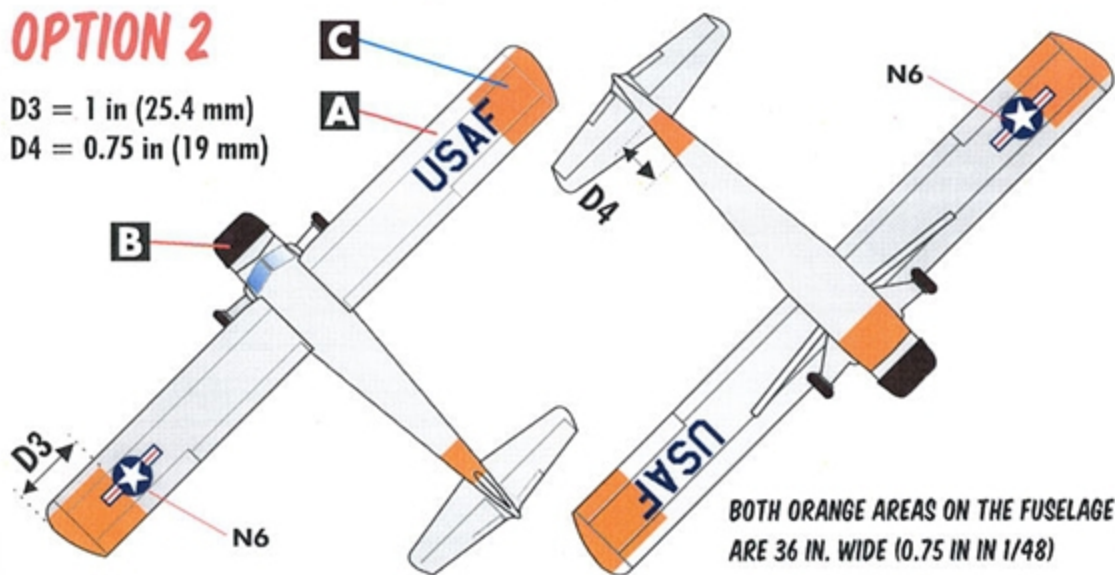

BOTH ORANGE AREAS ON THE FUSELAGE  
ARE 36 IN. WIDE (0.75 IN IN 1/48)

### OPTION 5

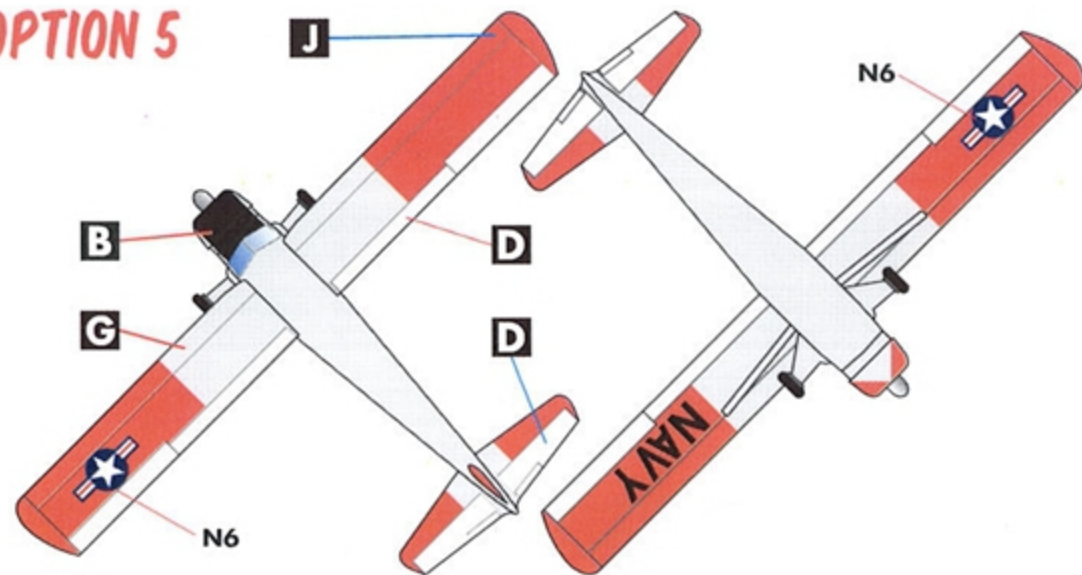

### OPTION 3

D5 = 0.83 in (21 mm)

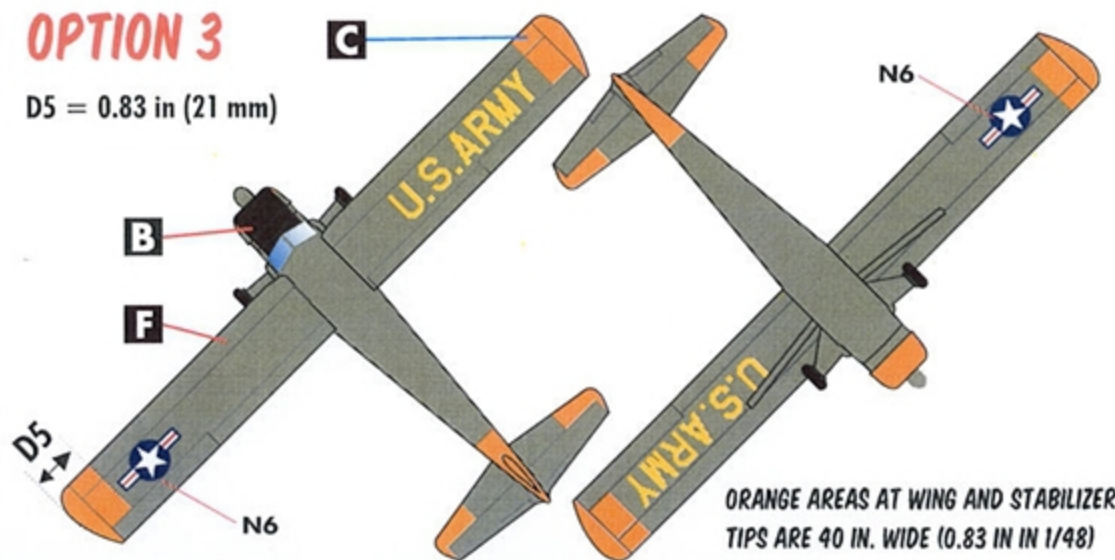

ORANGE AREAS AT WING AND STABILIZER  
TIPS ARE 40 IN. WIDE (0.83 IN IN 1/48)

### OPTION 6

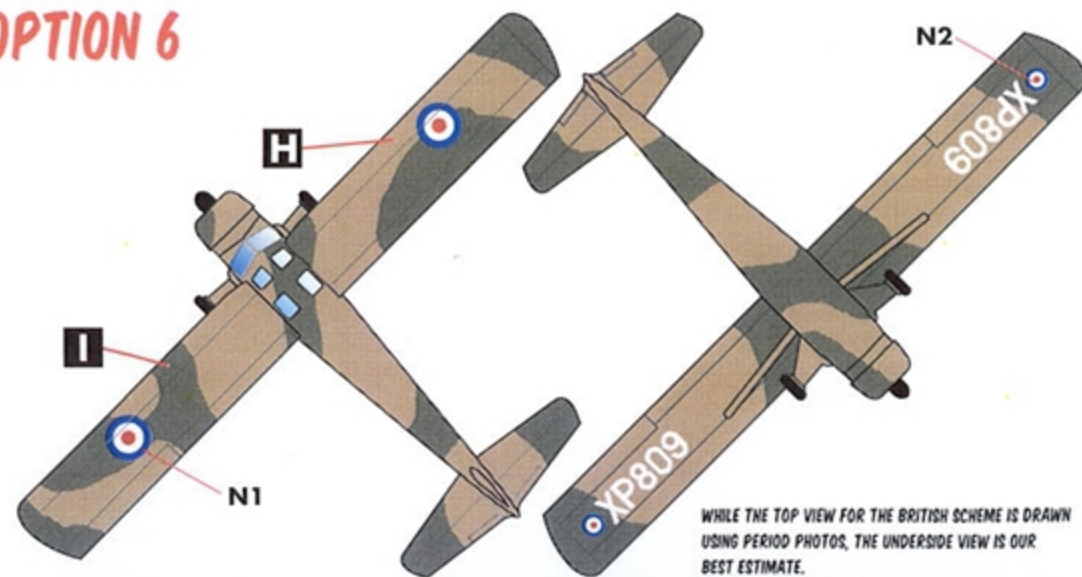

WHILE THE TOP VIEW FOR THE BRITISH SCHEME IS DRAWN  
USING PERIOD PHOTOS, THE UNDERSIDE VIEW IS OUR  
BEST ESTIMATE.



## OPTION 6: BEAVER AL MK.I XP809

### BRITISH ARMY

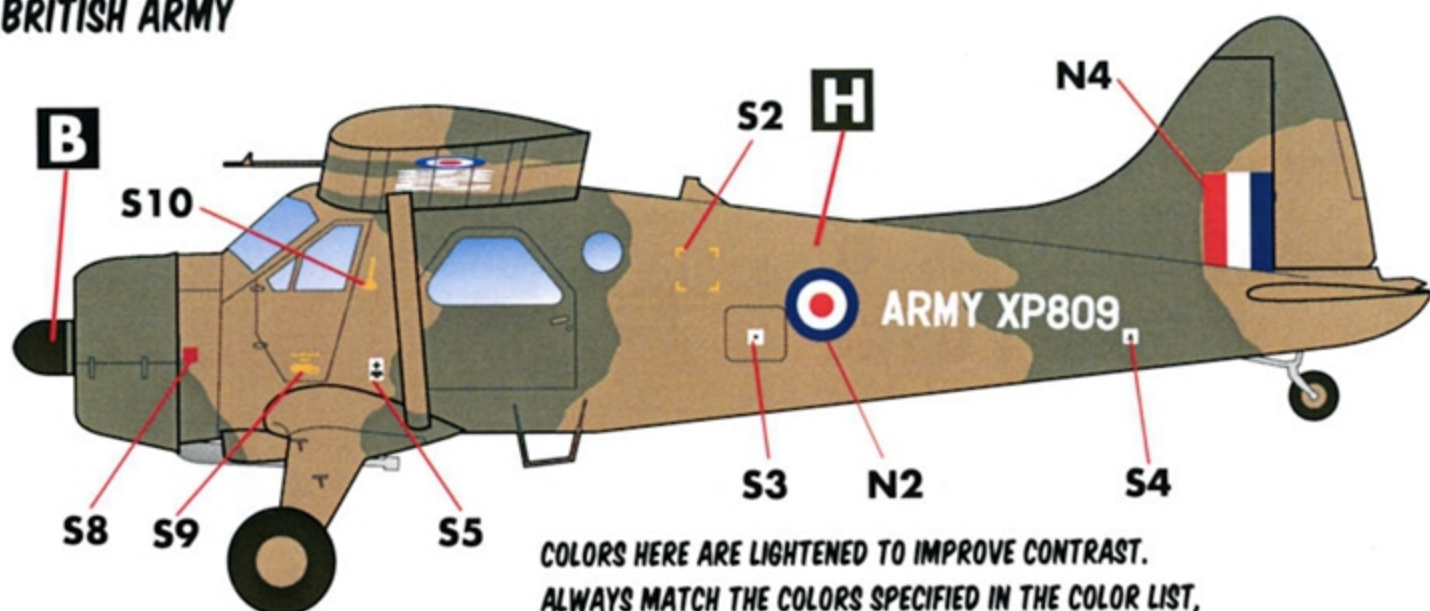

COLORS HERE ARE LIGHTENED TO IMPROVE CONTRAST.  
ALWAYS MATCH THE COLORS SPECIFIED IN THE COLOR LIST,  
AND NOT THE COLORS USED IN THE PROFILES!

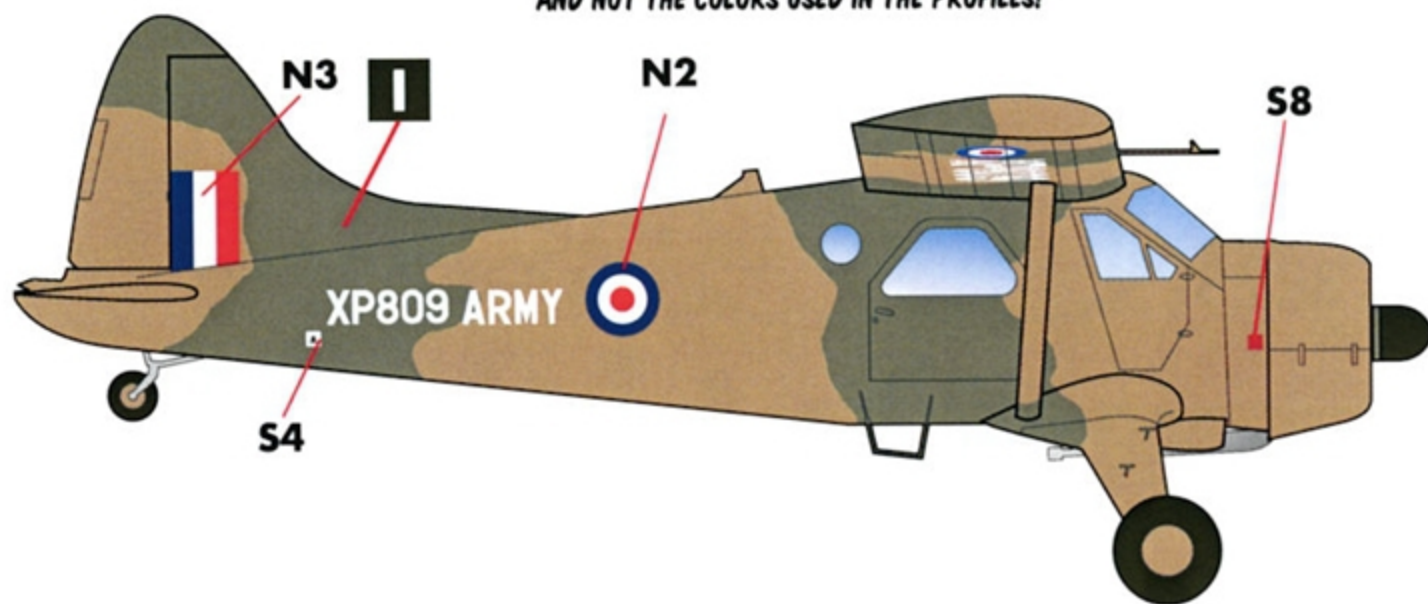

### COLOR LIST

- A** NATURAL METAL
- B** FLAT BLACK (FS37038)
- C** DAYGLO ORANGE
- D** FLAT WHITE (FS37875)
- E** INSIGNIA RED (FS11136)
- F** GLOSS OLIVE DRAB (FS14087)
- G** FLAT GULL GRAY (FS36440)
- H** DARK EARTH (BS381C-450)
- I** DARK GREEN (BS381C-241 )
- J** INTERNATIONAL ORANGE (FS12197)