

155mm Howitzer Carriage Model of 1918

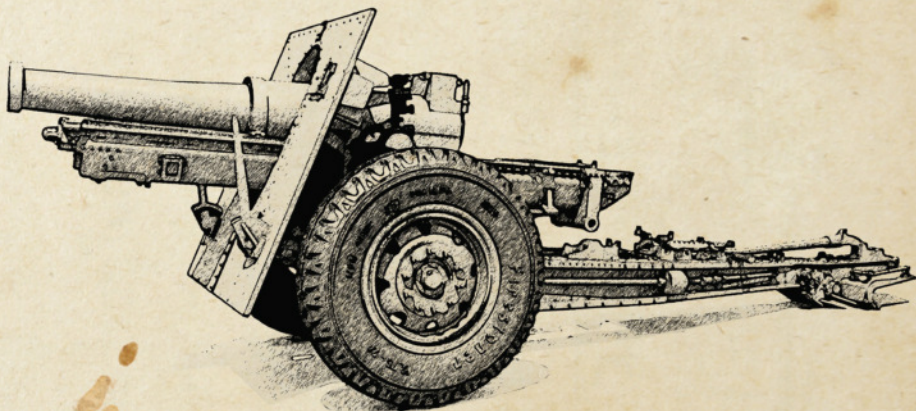

Schneider

28 March 1942

Known by many different names "Canon de 155 Mle 1917 Schneider C" (France, Belgium), "15.5cm sFH 414(f)" (German Afrikakorps), "Model 1918 155mm Howitzer - Schneider" (U.S.A.) this powerful and robust howitzer served in the armies of many nations during World War I, the Spanish Civil War, World War II, and even beyond. The last military to use the Schneider 155 was Finland, with a modified version serving in a training roll into the 1980s.

This boxing, Das Werk 35023, includes parts needed to build The U.S. Model 1918 version. The kit can be built in the travel or battery (firing) positions, with the breech open or closed, and includes accessories that would be common in a firing position. Shells of two types, along with their crates, as well as two styles of loading rammer, and the manual shell handling cradle, are also included. The shell handling cradle can be mounted to the chassis, as might be seen in travel or in museums, or it can be placed as an accessory in a diorama.

The U.S. Model 1918 served in the Pacific Theater of Operations in the early years of the war. The elements that make the U.S. version unique (pneumatic tires, flat shield, unique rear tow hitch and data plaque) are included in this boxing of the kit. For the World War I version, see Das Werk kit 35022.

**U.S. WWII version
in battery
(ready to fire)**

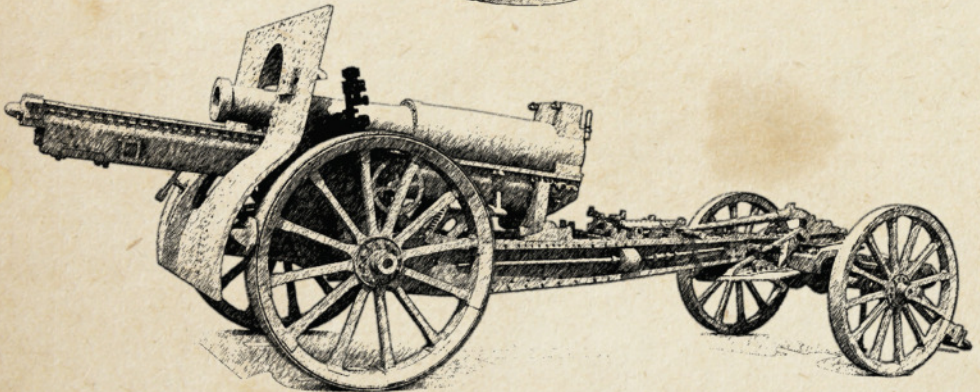
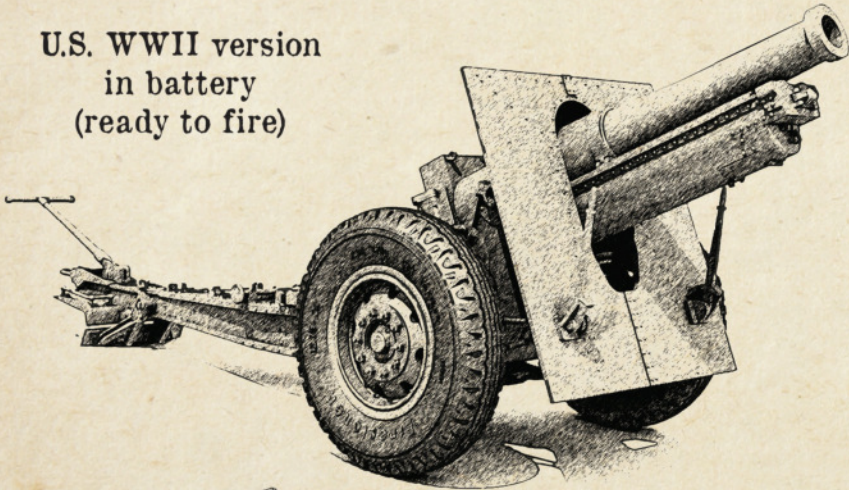

WWI Version (Das Werk 35022) in transport mode

Solomon Islands 1943



Warning: Choking hazard. Keep small bits and pieces away from toddlers. Use paint and glue in well-ventilated areas only, away from open flame. Wear protective gear while working with knives and while sanding. Protect your lungs from dust and fumes. Beware of sharp edges.

Assembly: Read the instructions carefully before starting assembly. Dry-fit parts and sub-assemblies before installing them.

Painting: Always run a paint test bed parallel to the project. Test chemical reactions and products from different brands for compatibility before combining different products on your model. Use the test bed to experiment with weathering effects as well.

Decals: Soak decals in warm water until they become loosened from the carrier film. Consider using softeners and setting solutions. Avoid trapping air bubbles under the decal. Seal decals with a clear coat after they have thoroughly dried.



CHECK BOX



OPTION



CAUTION



REPEAT



DECALS



ANNEAL



USE LITTLE GLUE



USE CA GLUE



REMOVE

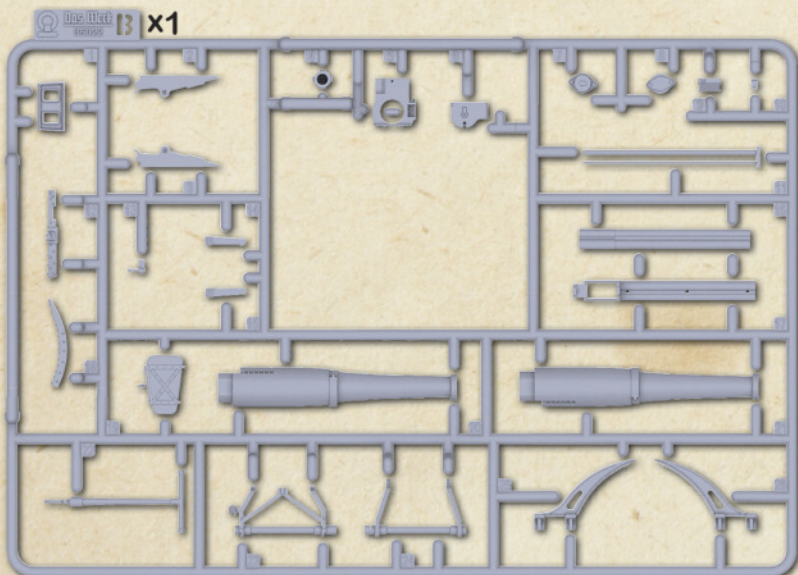
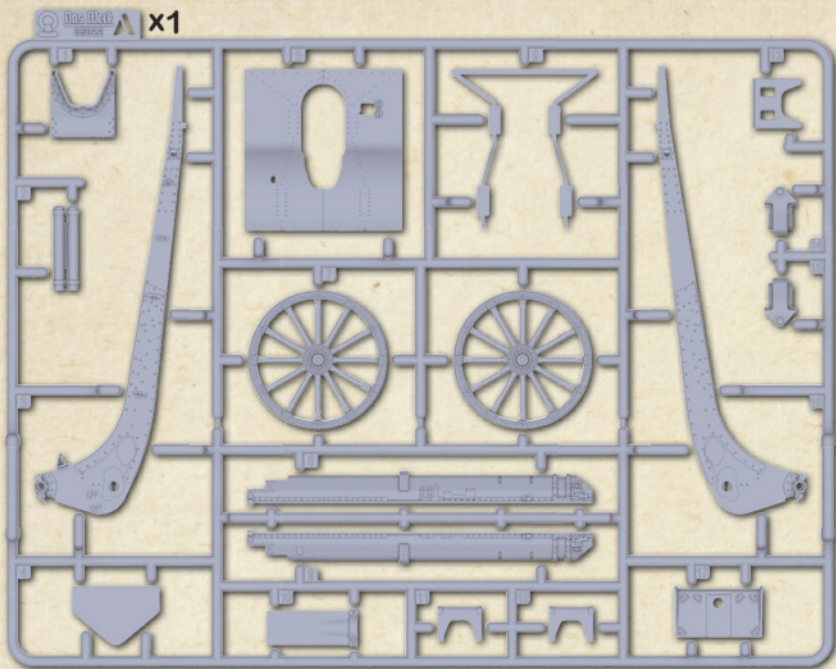

C x1

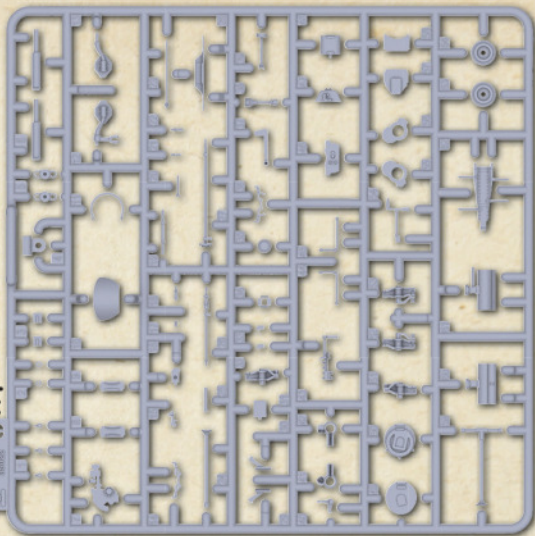

F x2

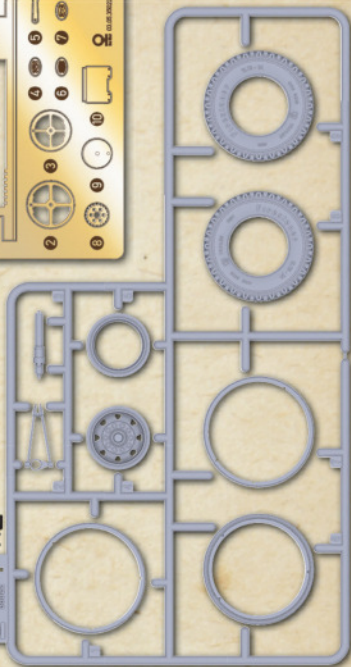

I x1

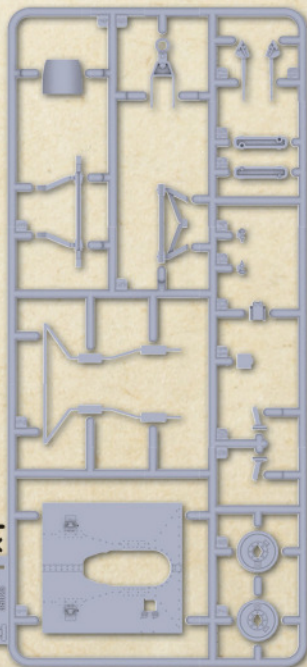

x1

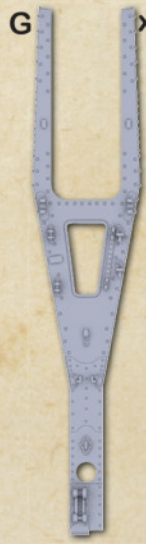

x1

E x1

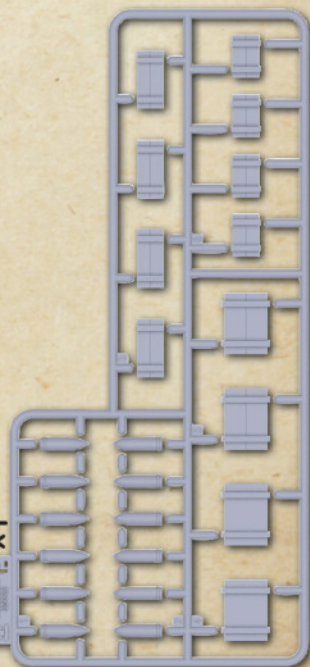

USMC Solomon Islands 1943

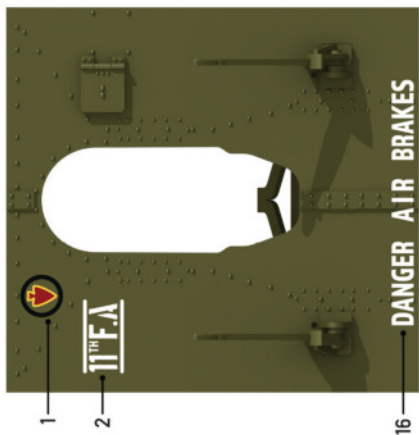

Pre-WWII alternate markings

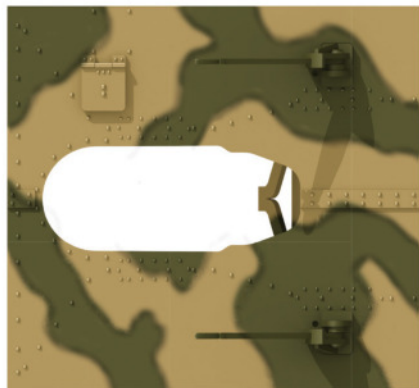
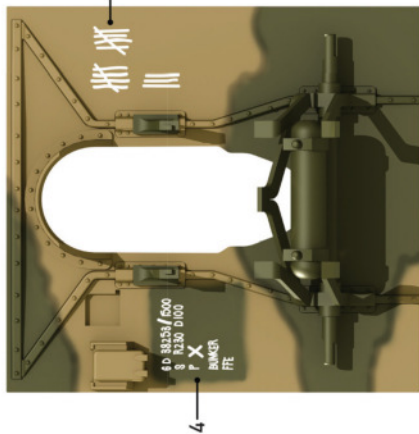

XF62
H52
926
71316
159
MMP024

TAMIYA
Mr Hobby H Series
AMMO of Mig
Vallejo
Humbrol
Mission Models

XF55
H321
202
71122
103
MMP011

TAMIYA
Mr Hobby H Series
AMMO of Mig
Vallejo
Humbrol
Mission Models

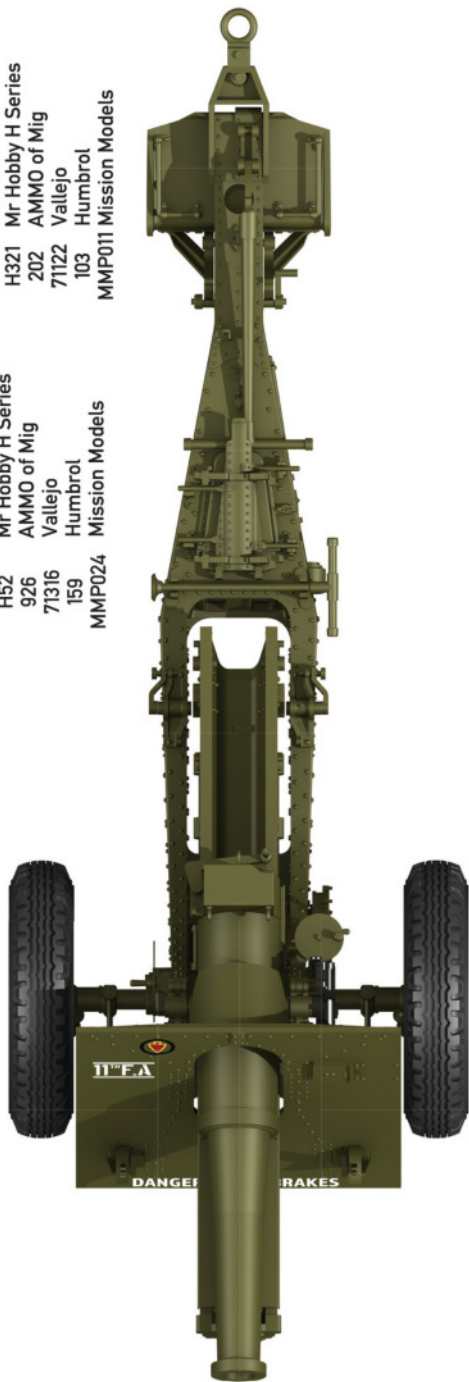

x 2
REPEAT

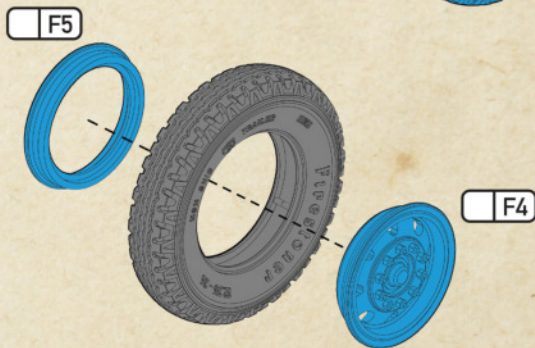
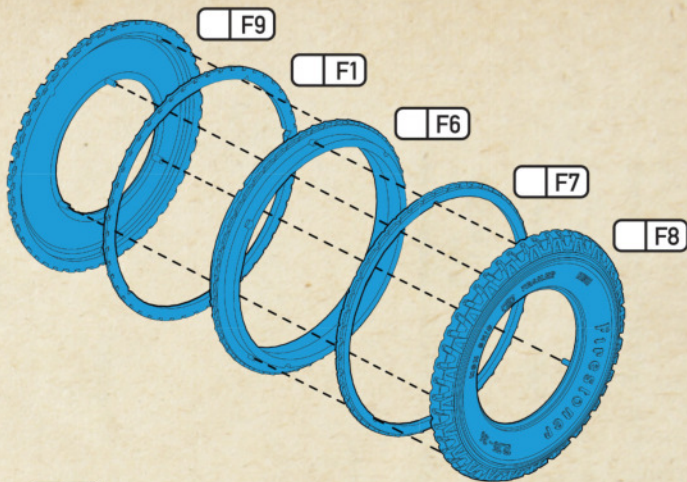

2 TYPES OF SHELL
ARE INCLUDED
(colors are speculative)

x 2
REPEAT



-CRATE LIDS CAN BE LEFT OFF.
-SHELLS CAN BE DISPLAYED OUTSIDE OF CRATE

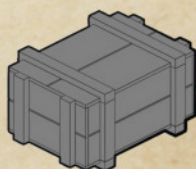
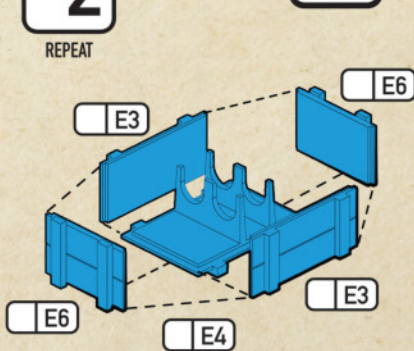

O.D. Green or WOOD color

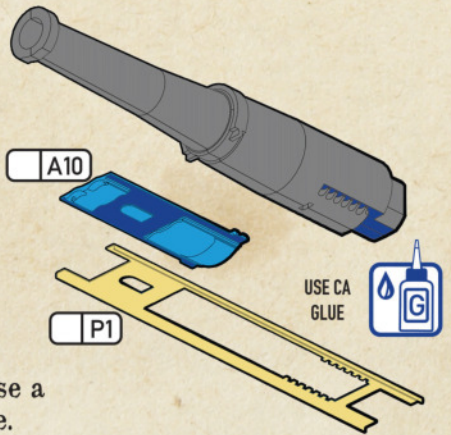
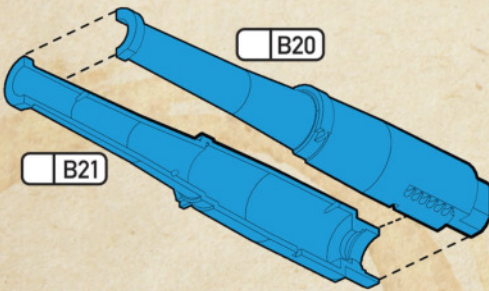
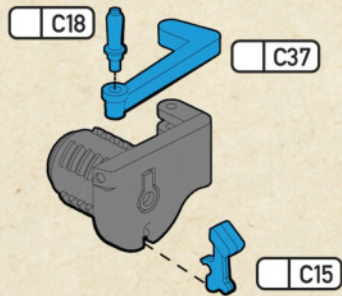
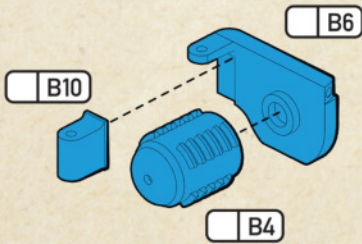
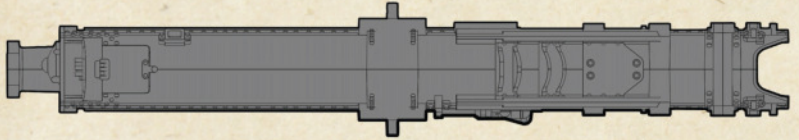
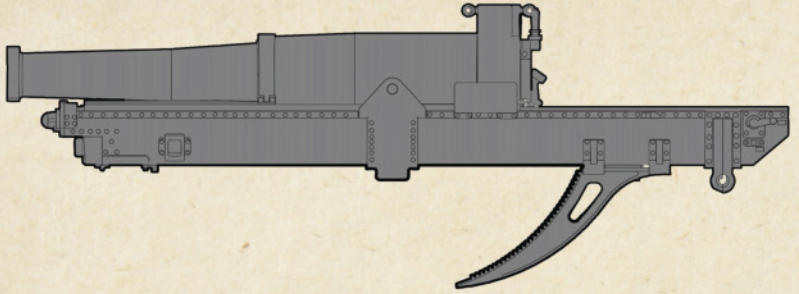
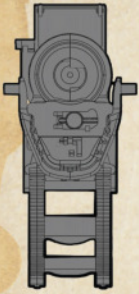

ANNEAL

Anneal part first. Work slowly, use a photoetch bending tool if possible.

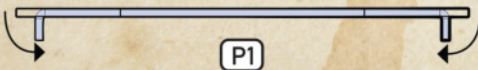

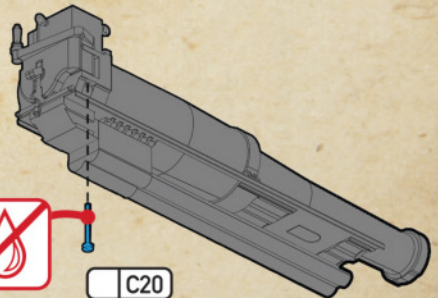
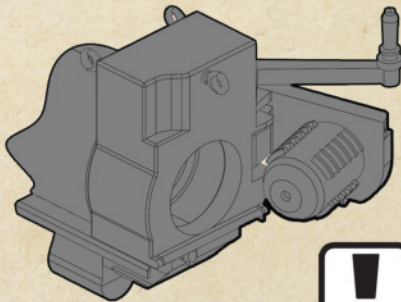
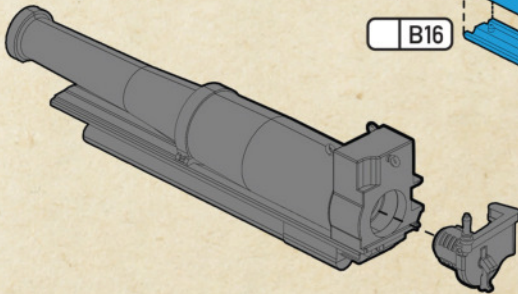
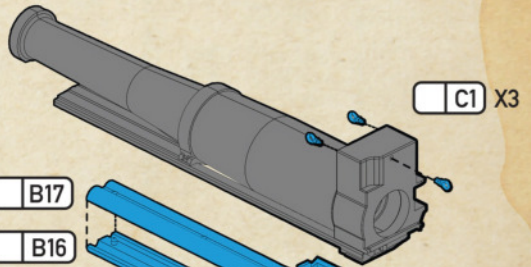
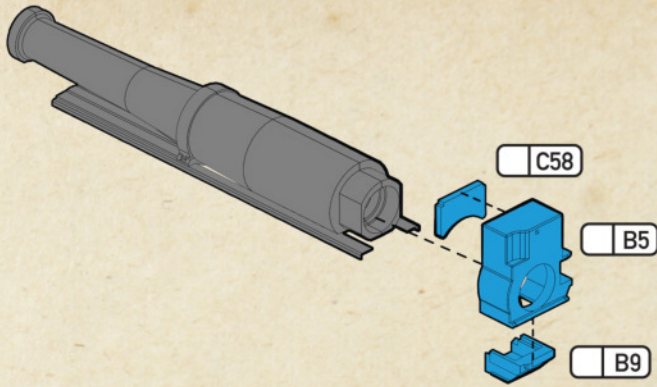

CAUTION



NO GLUE

C20

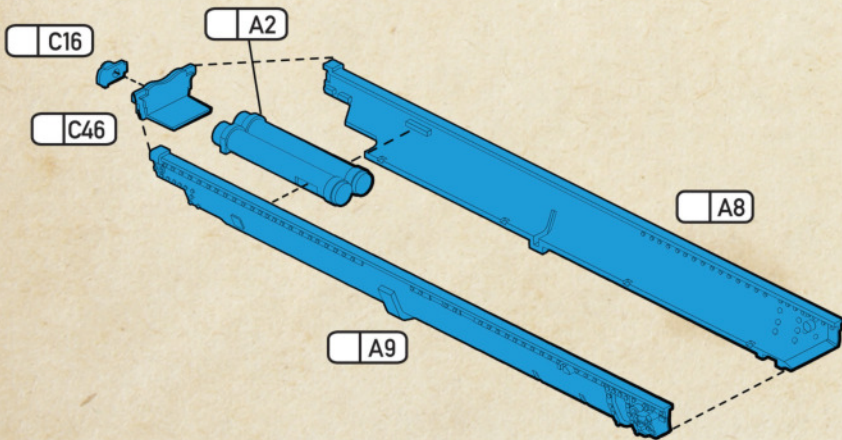
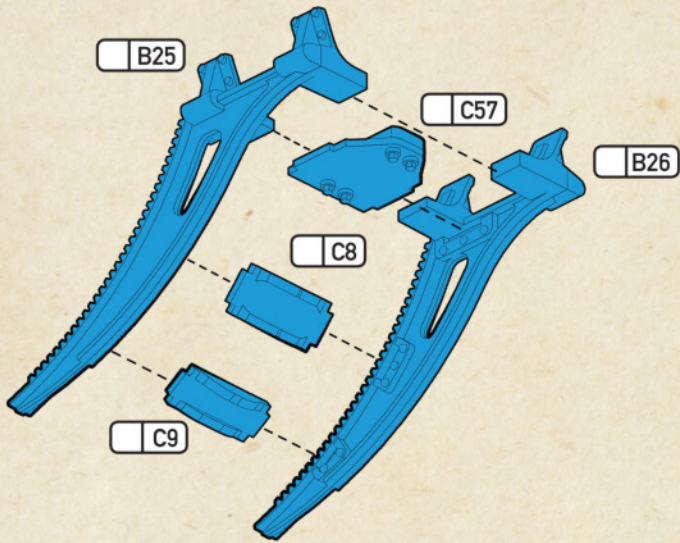

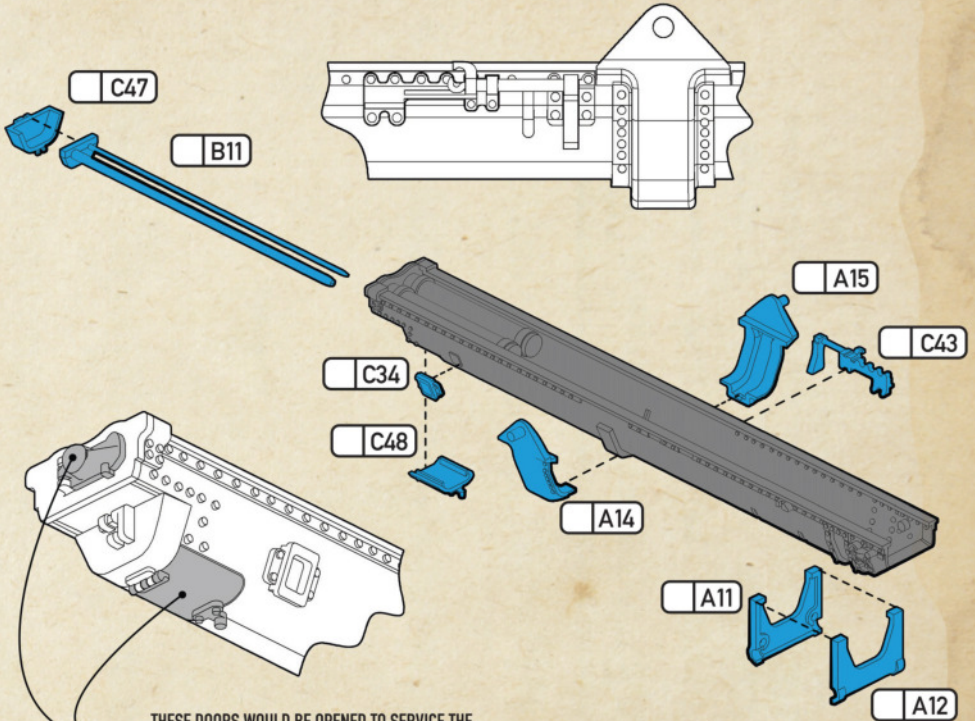

THESE DOORS WOULD BE OPENED TO SERVICE THE HYDRAULIC RECOIL CYLINDERS DURING USE AND MAINTENANCE

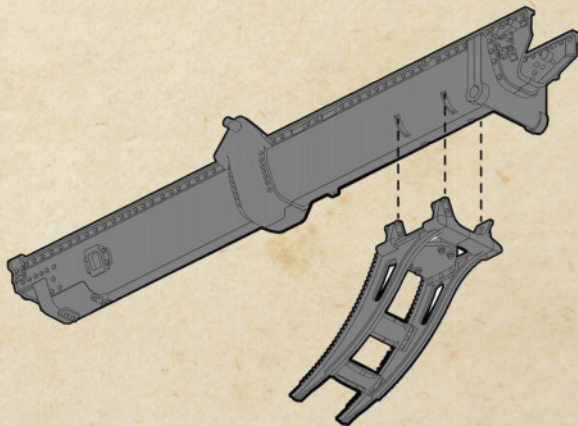

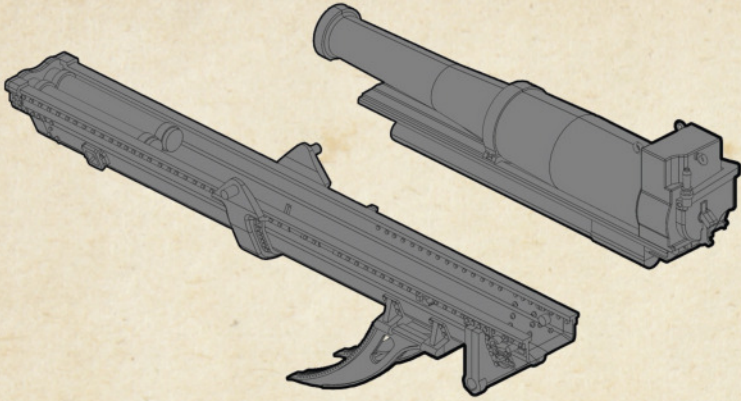

ANNEAL

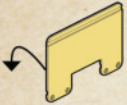

P10



P10

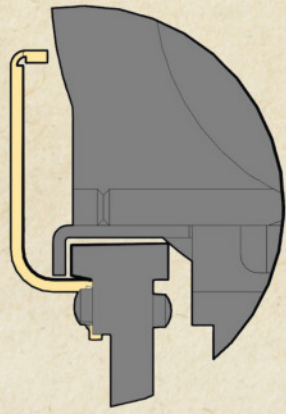
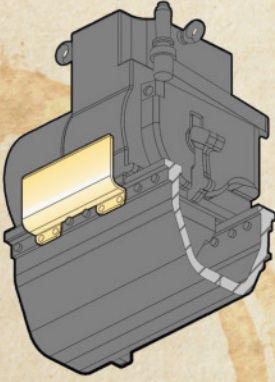
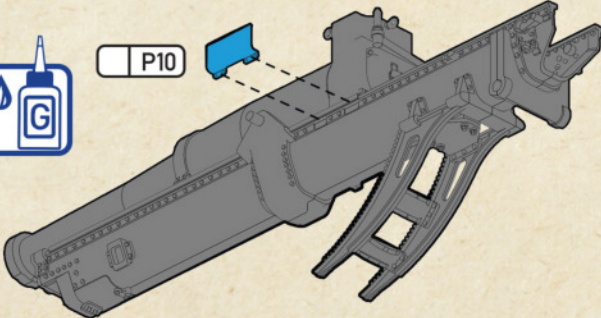

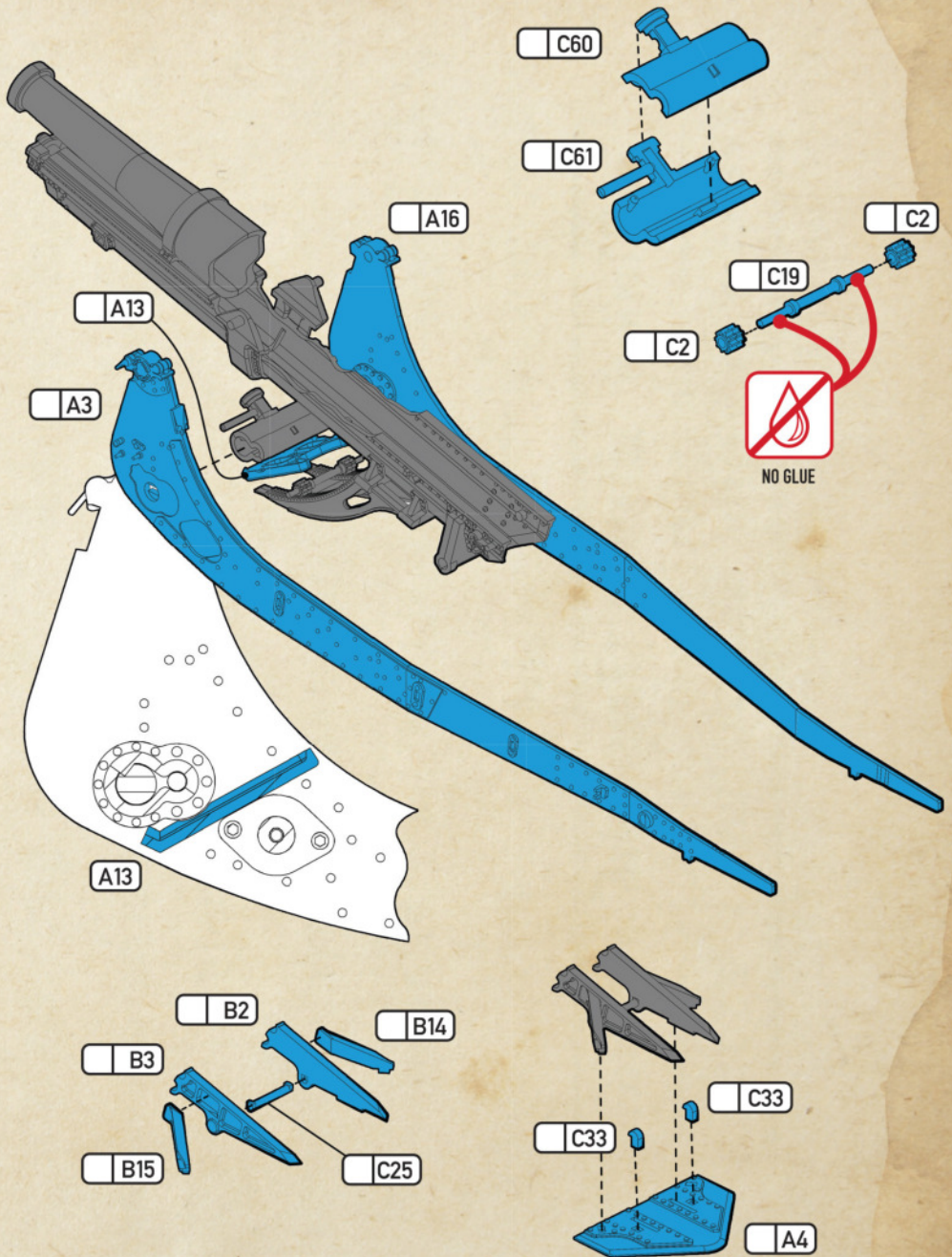

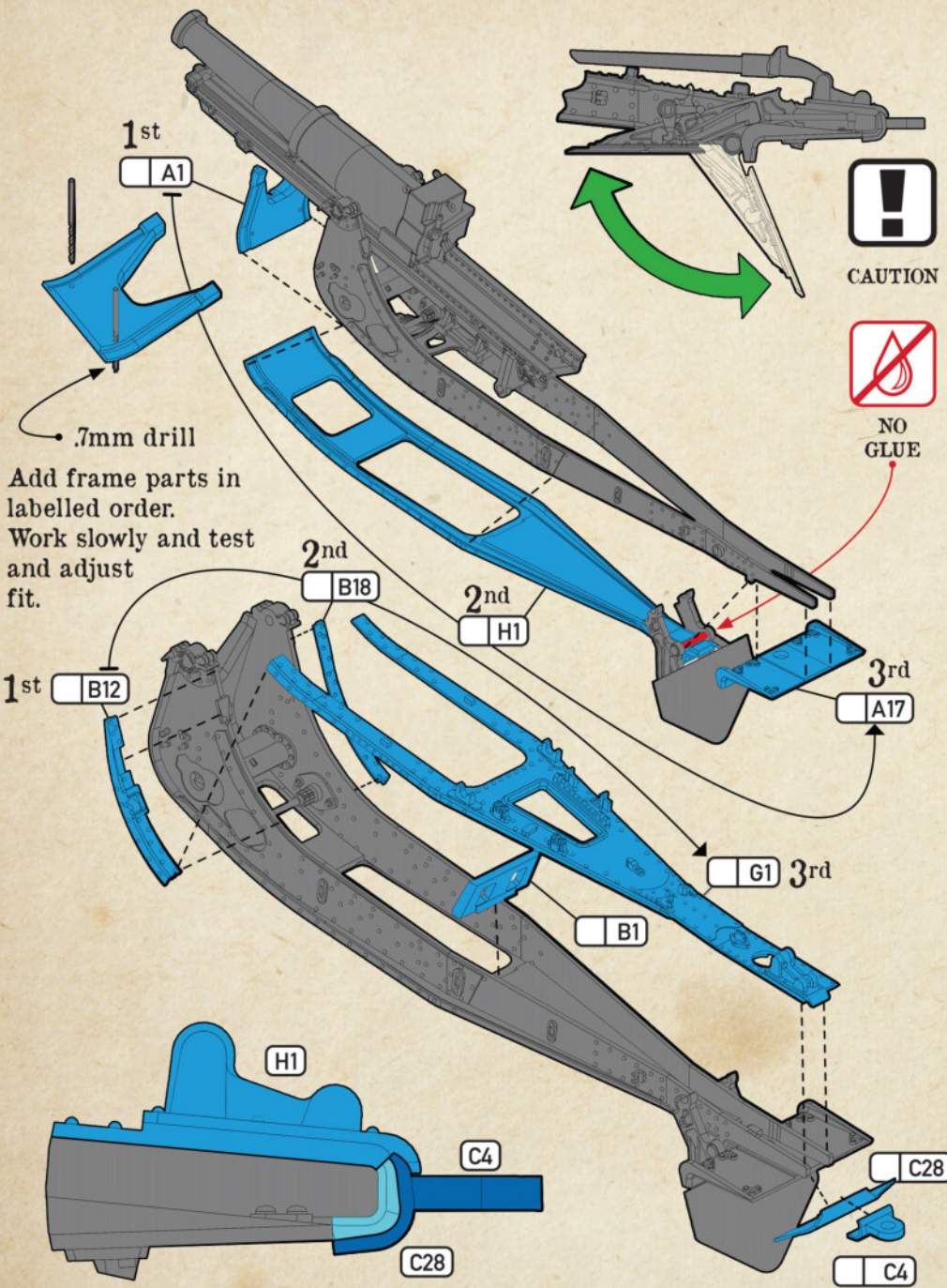

Add frame parts in
labelled order.
Work slowly and test
and adjust
fit.

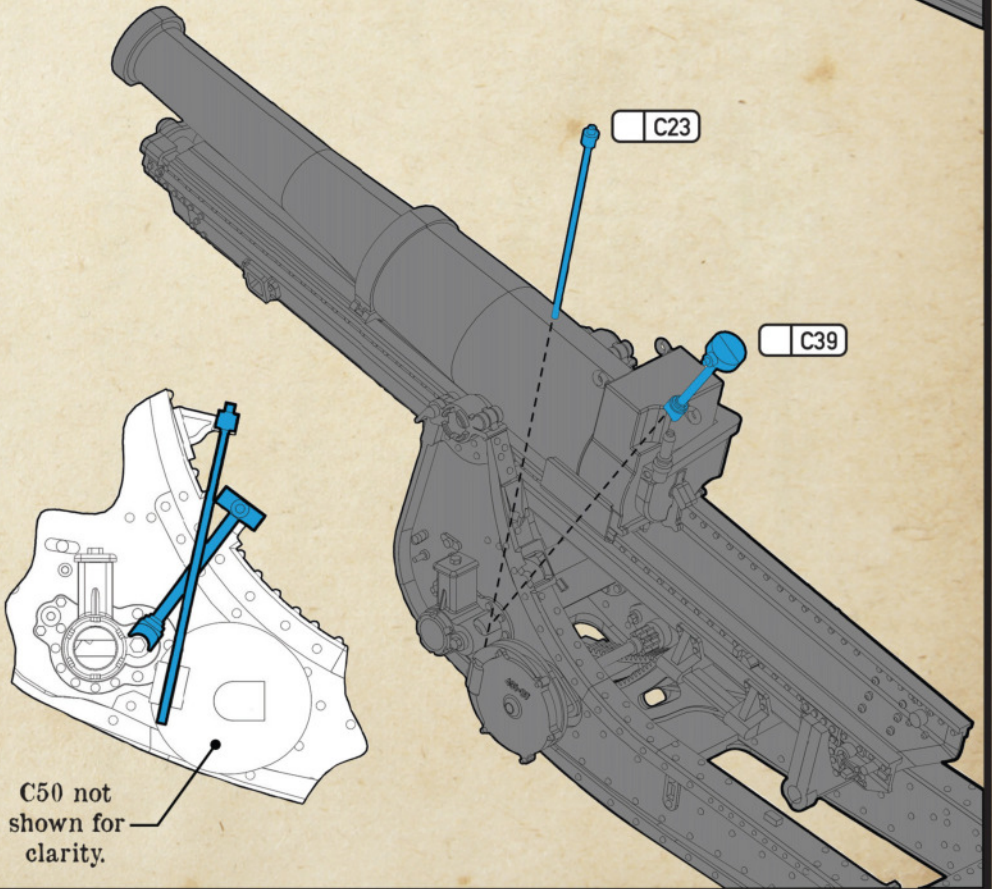
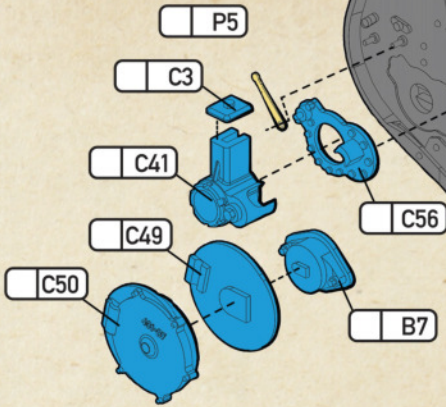

C50 not shown for clarity.

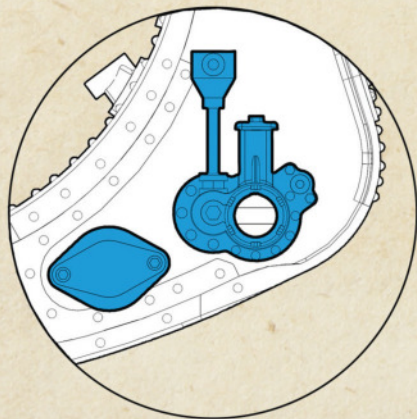
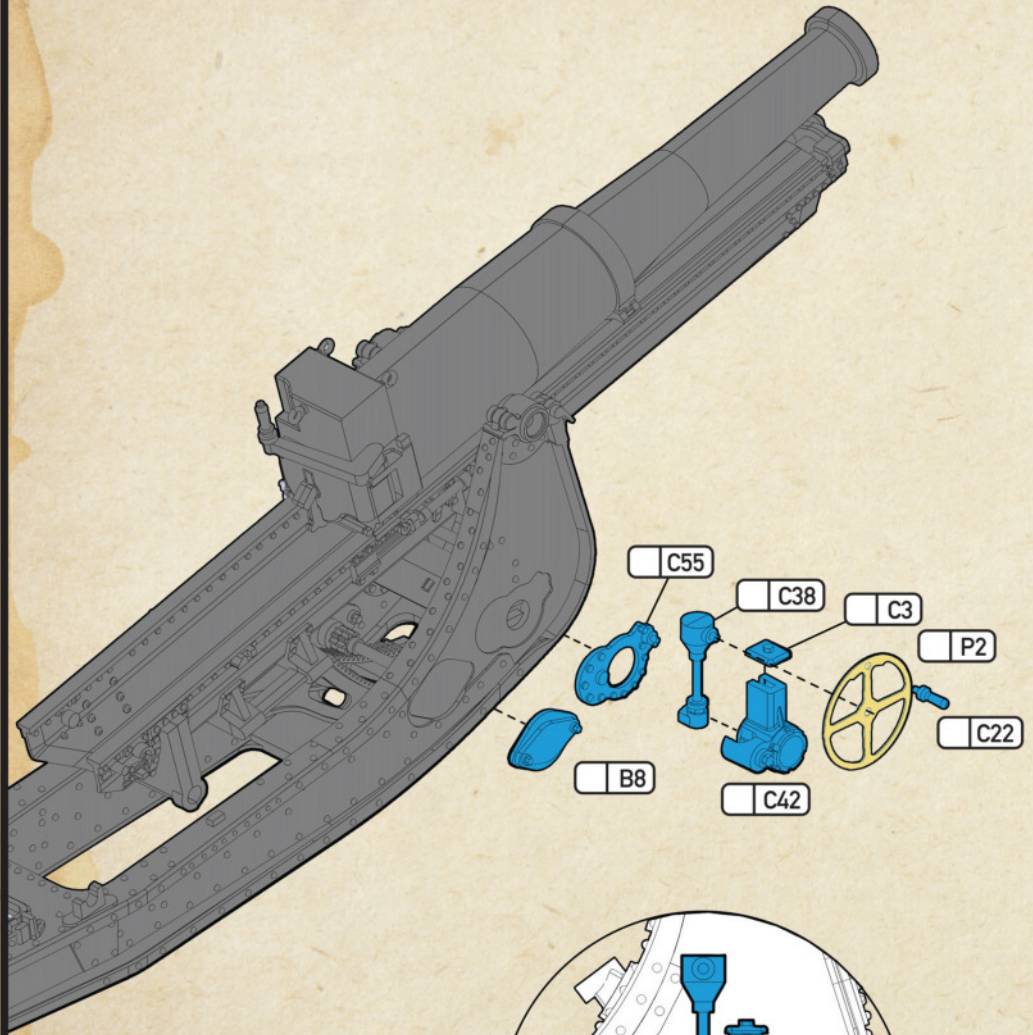



OPTION

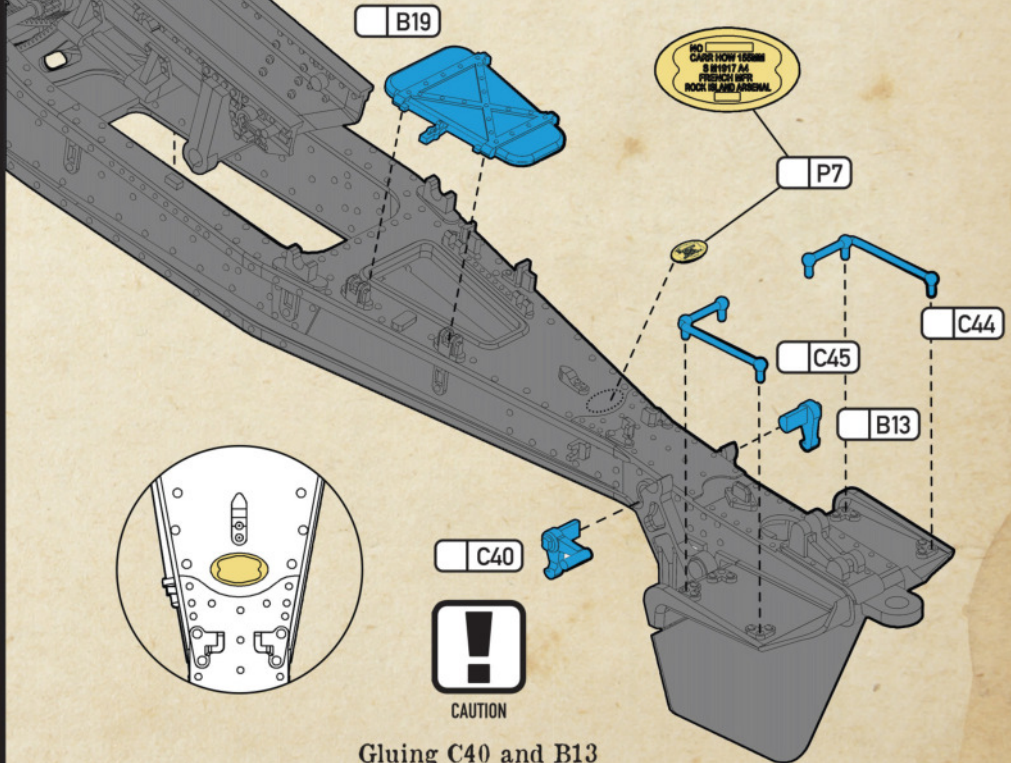
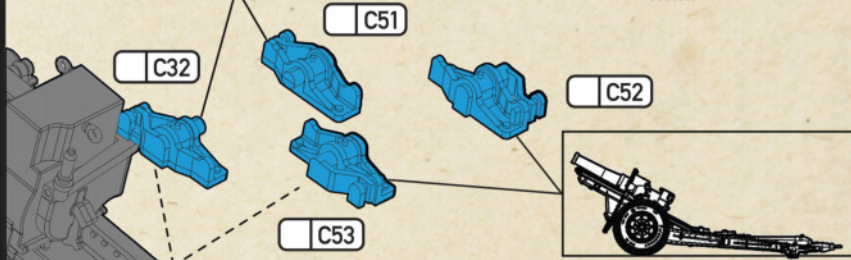

CAUTION

Gluing C40 and B13
will permanently fix
the rotating spade in
place



OPTION

C59

C24

C27

B22

C35

C26

C17

P9

P8



USE CA GLUE

C36

C14

C7

C62

C21

P3



USE CA GLUE

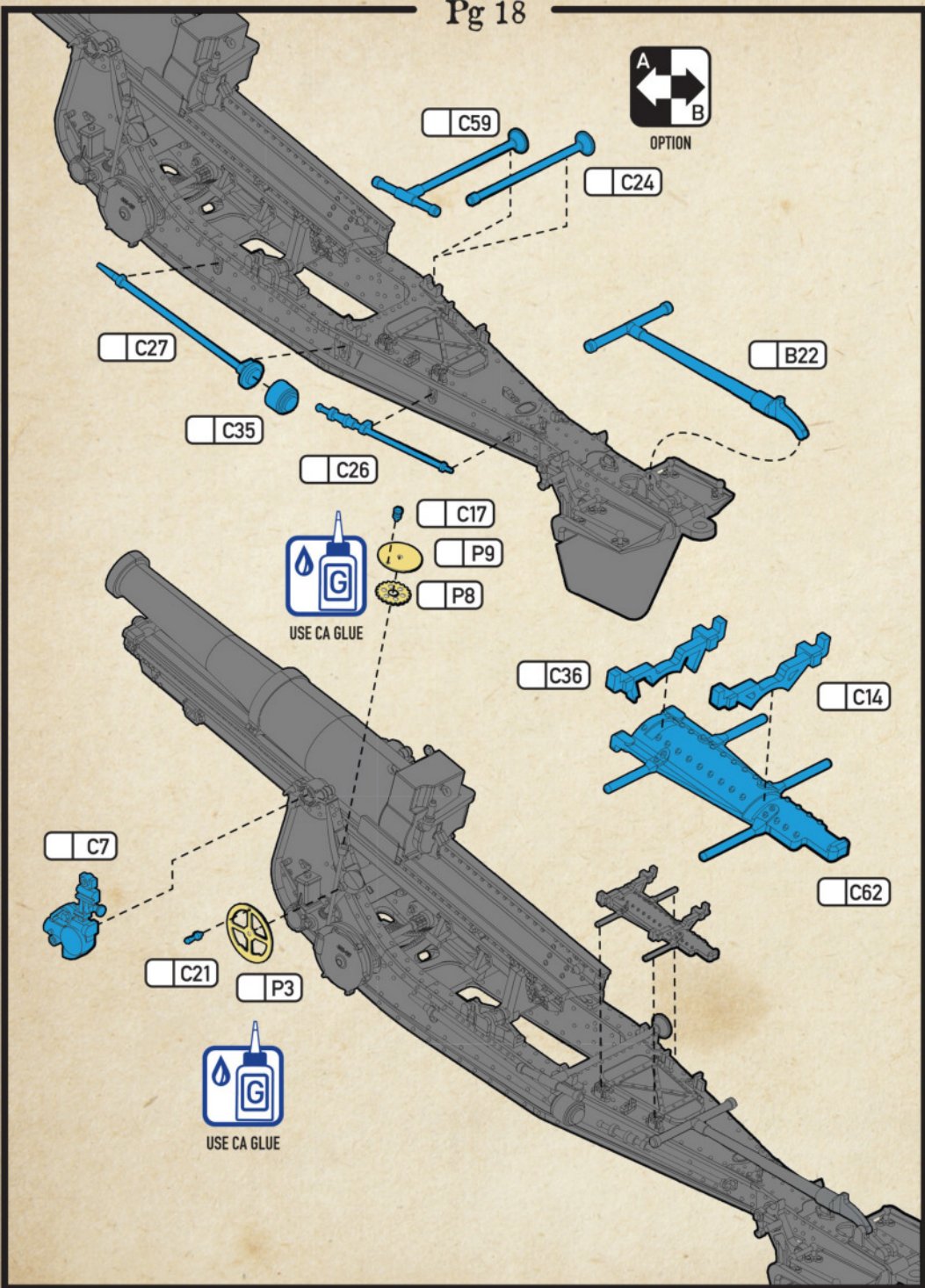

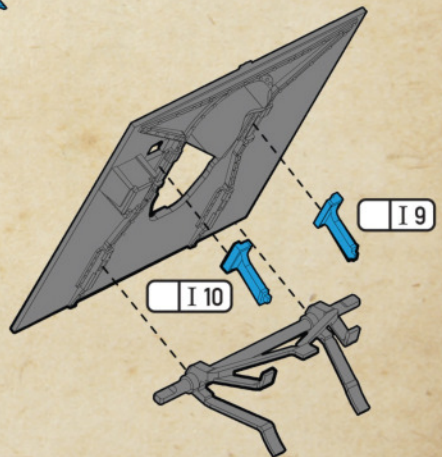
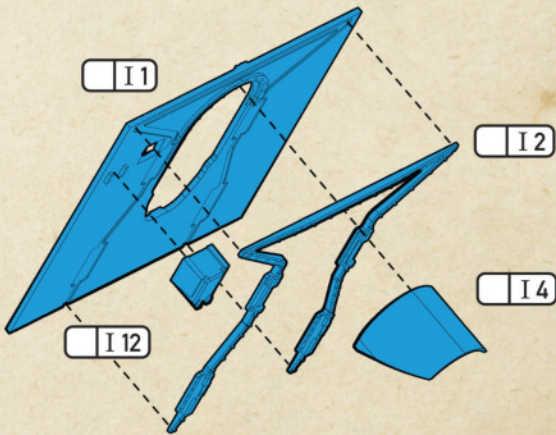
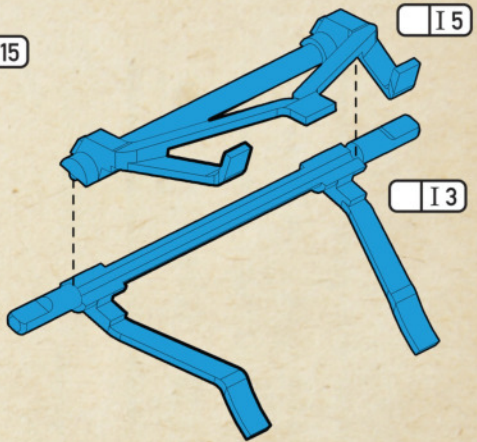
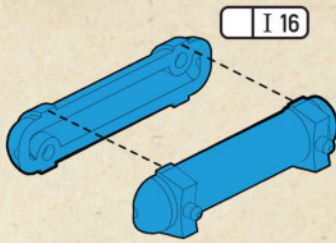

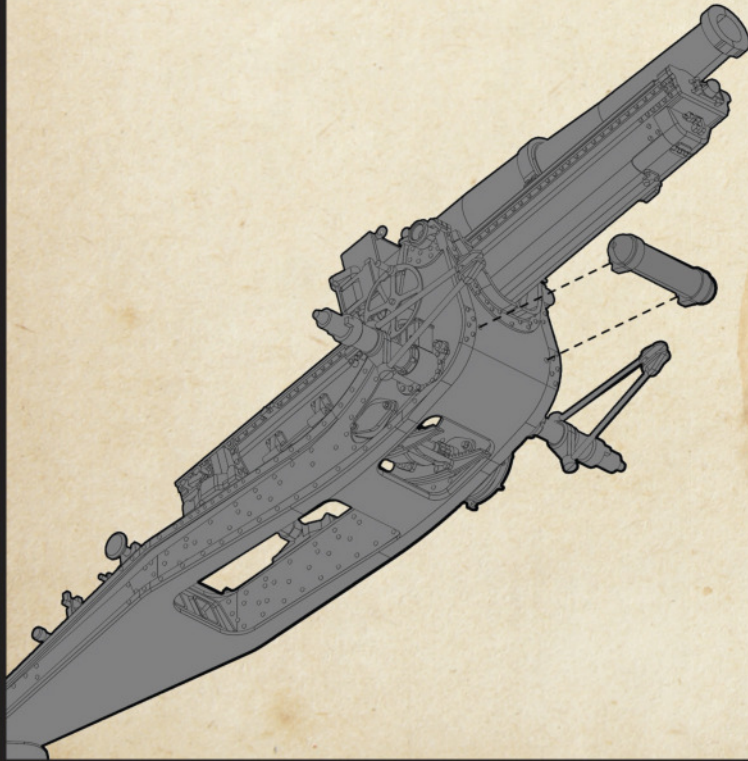
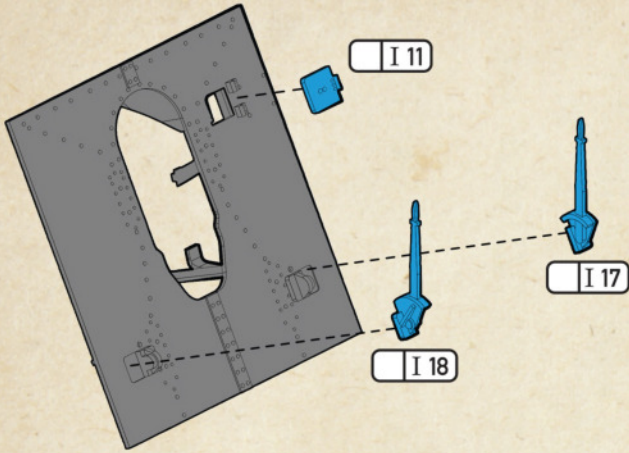

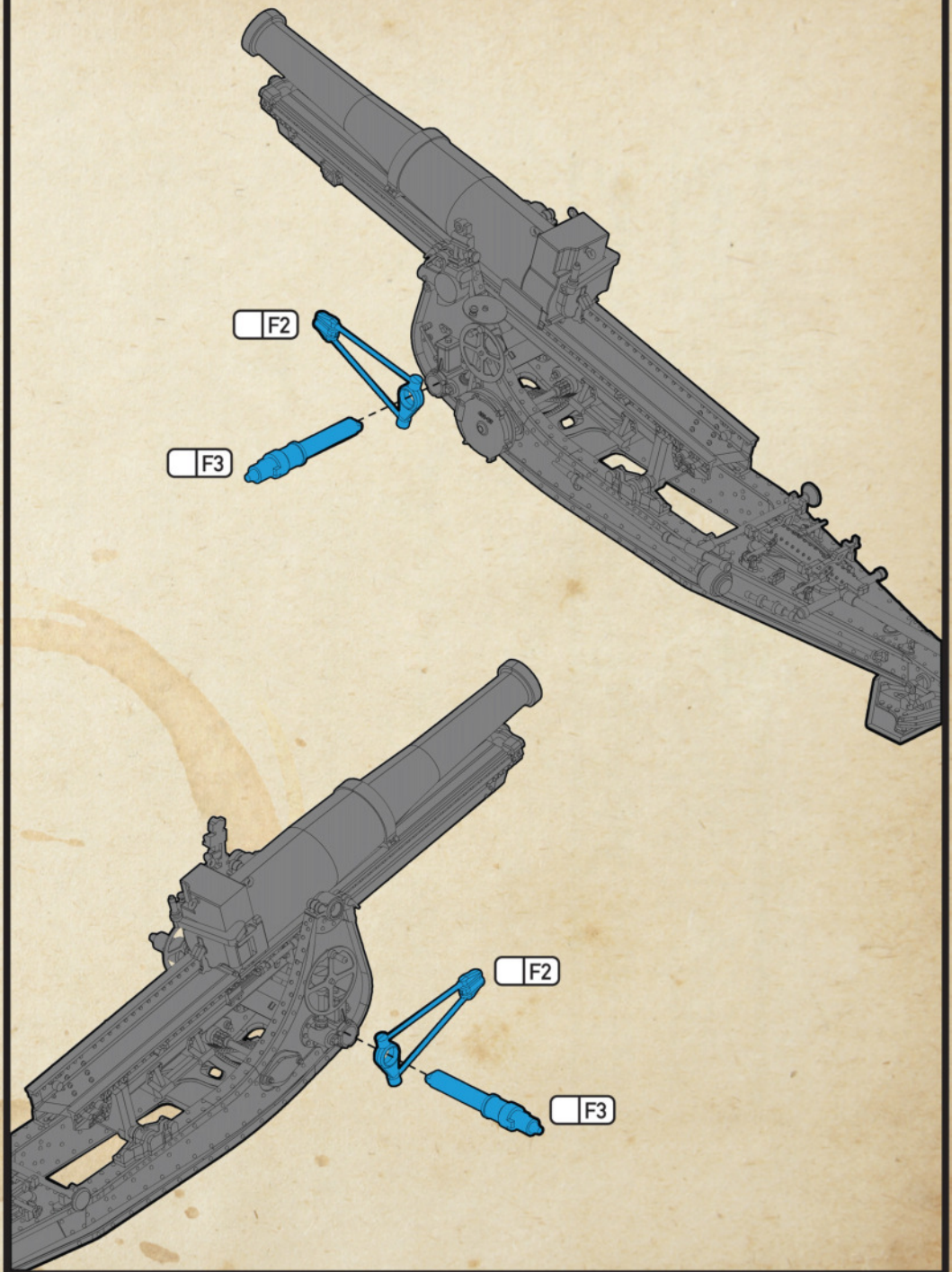

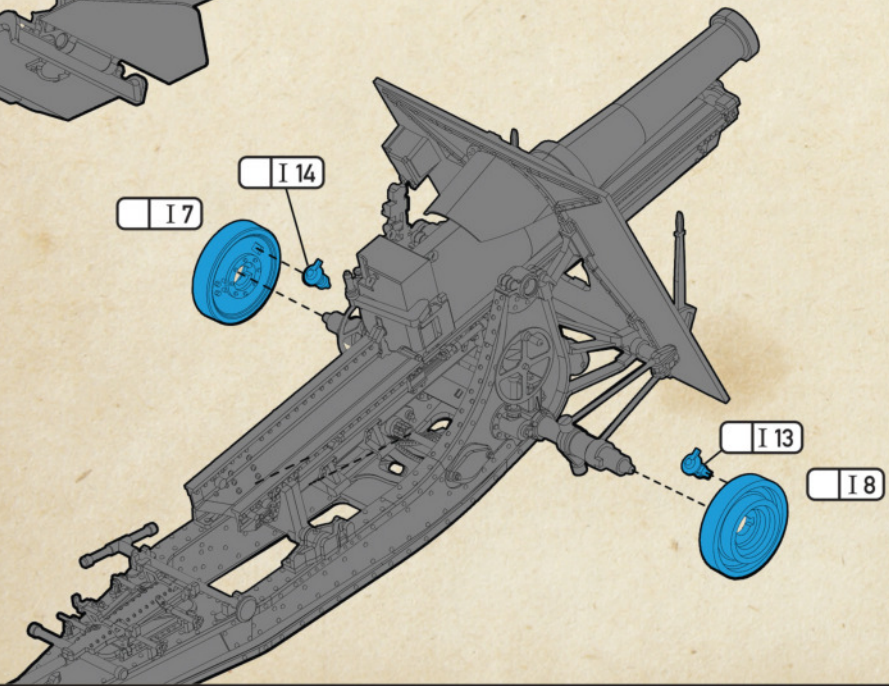
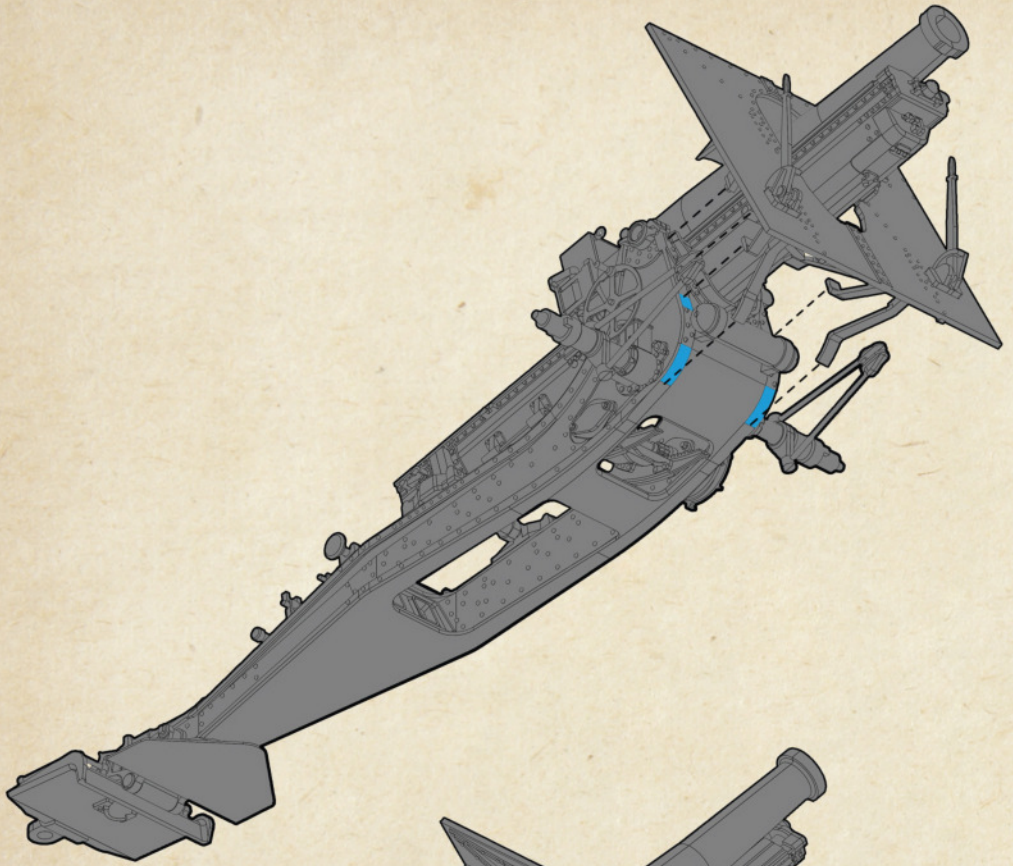

I6



REMOVE

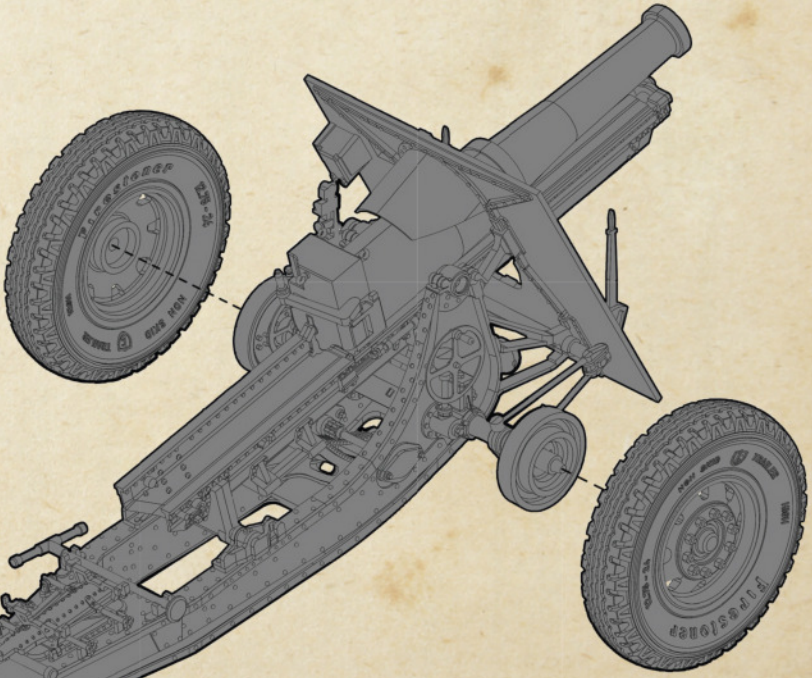



Harald Bauske ~ CEO

As the owner and managing director of Modellbau König GmbH & Co KG, Harald assembled a team of creative professionals and provided the budgets to pursue one of his dreams: releasing a plastic model kit under his own brand. Now, in late 2018, his dream has come true. Back in 1999, when he made the first steps with his company, he did not imagine that this dream would ever become a reality.

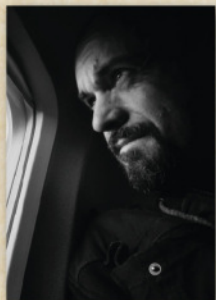

Pete Hamann ~ 3D designer, CAD modeler, Instruction manual design

Born and raised in California, Pete worked on his design chops as an aerospace designer in Seattle, Washington before packing up and relocating to Spain. He developed a deep interest in flying machines while growing up next to military air bases in Southern California. After spending a few years as a machinist, making other people's designs a reality, he obtained a bachelor of arts degree in industrial design.

Pete can be reached at Peterjhamann@gmail.com

This project would not have been possible without the help of:

Guillem Marti Pujol
Juanjo López
Chris "Toadman" Hughes

Special thanks to:
Rafael Paniagua (Maquetas RPM Getafe, Madrid)

A DAS WERK & Custom Scale production

2021

Modellbaukönig GmbH & Co. KG

Nordenhamer Str. 177

27751 Delmenhorst

Deutschland